

India's First

Complete Sanitary
Product Brand

More Than 500 Products
Under A Roof



BAJAJ [®] _©

International Quality in Indian Price

PIPING SYSTEM | BATH FITTINGS | BATH ACCESSORIES

JOURNEY SO FAR

India's First Complete Sanitary Product Brand



Start Agriculture Pipes	1998
Start UPVC Pipes & Fittings	2008
Start CPVC Pipes & Fittings	2011
Start SWR Pipes & Fittings	2014
Start Garden & Hose Pipes	2015
Start Conduit Pipes & Fittings	2016
Start Stainless Steel Sink	2017
Start CP Bath Fitting	2019
Start Bath Accessories	2020

WE ARE **NOT STOP**
THERE ARE LOTS MORE PRODUCTS **IN FUTURE...**



OUR PRODUCTS INDIAN STANDARDS INSTITUTION (ISI)

<p>IS:15778</p>  <p>CPVC PIPES</p>	<p>IS:13592</p>  <p>SWR PIPES</p>	<p>IS:14735</p>  <p>SWR FITTINGS</p>	<p>IS:4985</p>  <p>AGRICULTURE PIPES</p>	<p>IS:7834</p>  <p>AGRICULTURE FITTING</p>	<p>IS:9537-PART3</p>  <p>CONDUIT PIPES</p>
<p>IS:4984</p>  <p>HDPE PIPES</p>	<p>IS:13049</p>  <p>CISTERN ACCESSORIES</p>	<p>IS:2548</p>  <p>TOILET SHEET COVER</p>	<p>IS:9763</p>  <p>P.T.M.T. TAPS</p>		

CLIENTELE



CONTENTS



PIPES & FITTINGS

CPVC	01
SWR	05
AGRICULTURE	08
UPVC	10
GARDEN	14
SUCTION HOSE	15
BRAIDED HOSE	16
MDPE	17
CONDUIT	18
CLAMPS	20
UV CABLE TIE	21
DRY WALL SCREW	21
HDPE	22
P.T.M.T. TAPS & ACCESSORIES	23
CISTERN	28
CISTERN ACCESSORIES	31
SEAT COVER	32
SEAT COVER ACCESSORIES	36
STEEL SINK	37

FAUCETS

PENDLE	47
SMART	49
TRUMP	51
MODERN	53
PORUS	55
ROMAN	57
TUCO	59
RAID	61
ANSHUL	63
SIGNATURE	65
ORIS	67
ORIO	69
OZONE	71
ANMOL	73
SCOTT	75
CHOCOLATE	77
REAL	79
LORET	81
ALIVE	83
PERFECT	85
FINE	87
MEDICAL	89
SINGLE LEVER SINK	90
MOUTH OPERATED	91
PUSH OPERATOR	92
HIGH NECK	93
SINGLE LEVER NECK	95
ACCESSORIES	96
JET SPRAY	98
SHOWERS	99
TELEPHONIC SHOWER ABS	105
BRASS HEALTH FAUCETS	108
ABS HEALTH FAUCETS	110

BAJAJ Chlorinated Poly Vinyl Chloride (CPVC) Pipes and Fittings are manufactured from a specially formulated compound in accordance with Indian Standard **IS 15778 & ASTM D 2846 specifications**. These pipes and fittings are a perfect choice having many advantage over the conventional systems as they are corrosion free and resistant to most acids, bases, salts and halogens.

Product Range

Pipes -15 to 50mm (½” to 2”) sizes in SDR 11 and SDR 13.5 as per IS:15778. 65 to 110mm (2½” to 4”) sizes in SCH 40 and SCH 80 as per ASTM F-441.

Fittings-15 to 50mm (½” to 2”) size in SDR 11 as per ASTM D-2846 20 and 25mm 65 to 110mm (2½” to 4”) sizes in SCH 40 and SCH80 as per ASTM F-438 and F-439 respectively.

Fields of Application

BAJAJ C-PVC is designed for hot and cold water supply in residential, commercial and public projects, high and low rise buildings, corporate houses and academic institutes, solar heater applications etc. It is highly suitable for all uptake and down take lines, terrace looping including concealed pipe work applications.

Minimum Dimensions From Center to End of socket (Laying Length)							
SDR 11 Fittings							
Inch	mm	Inch	mm	Inch	mm	Inch	mm
½	15	0.382	9.7	0.183	4.65	0.102	2.59
¾	20	0.507	12.88	0.235	5.97	0.102	2.59
1	25	0.633	16.08	0.287	7.29	0.102	2.59
1¼	32	0.758	19.25	0.339	8.61	0.102	2.59
1½	40	0.884	22.45	0.391	9.93	0.102	2.59
2	50	1.134	28.83	0.495	12.57	0.102	2.59

DIMENSIONS OF SDR 11 (CLASS 1) CPVC PIPES-IS 15778						
Nominal Size Inch	Nominal mm	Nominal OD	Wall Thickness		Working Pressure/Kg/cm ²	
					27° C	82° C
½	15	15.9	1.7	2.2	27.6	6.8
¾	20	22.2	2.0	2.5	27.6	6.8
1	25	28.6	2.6	3.1	27.6	6.8
1¼	32	34.9	3.2	3.7	27.6	6.8
1½	40	41.3	3.8	4.3	27.6	6.8
2	50	54.0	4.9	5.5	27.6	6.8
DIMENSIONS OF SCH 80 CPVC PIPES - ASTM F 441						
2½	65	73.02	7.01	7.85	29.54	7.38
3	80	88.9	7.62	8.53	26.02	6.52
4	100	114.3	8.56	9.58	22.5	5.62

DIMENSIONS OF SDR 13.5 (CLASS 2) CPVC PIPES-IS 15778						
Nominal Size Inch	Nominal mm	Nominal OD	Wall Thickness		Working Pressure/Kg/cm ²	
					27° C	82° C
½	15	15.9	1.4	1.9	21.8	5.5
¾	20	22.2	1.7	2.2	21.8	5.5
1	25	28.6	2.1	2.6	21.8	5.5
1¼	32	34.9	2.6	3.1	21.8	5.5
1½	40	41.3	3.1	3.6	21.8	5.5
2	50	54.0	4.0	4.6	21.8	5.5
DIMENSIONS OF SCH 40 CPVC PIPES - ASTM F 441						
2½	65	73.02	5.16	5.80	27.1	5.27
3	80	88.9	5.49	6.10	18.28	4.57
4	100	114.3	6.02	6.70	15.47	3.87



CAT NO.	SIZE (mm)	SIZE (Inch)	STD. PACK	RATE (mtr)	RATE (3mtrs / pc)	RATE (5mtrs / pc)
CPVC PIPES - SDR 11						
CP1115	15	½	75	65.00	195.00	325.00
CP1120	20	¾	60	112.00	336.00	560.00
CP1125	25	1	30	188.00	564.00	940.00
CP1132	32	1¼	25	274.00	822.00	1370.00
CP1140	40	1½	15	392.00	1176.00	1960.00
CP1150	50	2	10	634.00	1902.00	3170.00
CPVC PIPES - SCH 80						
CP8065	65	2½	5	1750.00	5250.00	8750.00
CP8080	80	3	3	2370.00	7110.00	11850.00
CP80100	100	4	2	3560.00	10680.00	17800.00

CAT NO.	SIZE (mm)	SIZE (Inch)	STD. PACK	RATE (mtr)	RATE (3mtrs / pc)	RATE (5mtrs / pc)
CPVC PIPES - SDR 13.5						
CP1315	15	½	75	56.00	168.00	280.00
CP1320	20	¾	60	100.00	300.00	500.00
CP1325	25	1	30	158.00	474.00	790.00
CP1332	32	1¼	25	238.00	714.00	1190.00
CP1340	40	1½	15	326.00	978.00	1630.00
CP1350	50	2	10	541.00	1623.00	2705.00
CPVC PIPES - SCH 40						
CP4065	65	2½	5	1220.00	3660.00	6100.00
CP4080	80	3	3	1650.00	4850.00	8250.00
CP40100	100	4	2	2250.00	6750.00	11250.00

CAT NO.	STD. SIZE (mm)	STD. SIZE (Inch)	STD. PACK	STD. PACK	RATE (pc)
COUPLER					
CPF15C	15	½	100	900	10.40
CPF20C	20	¾	100	700	14.00
CPF25C	25	1	50	300	27.10
CPF32C	32	1¼	50	200	42.10
CPF40C	40	1½	20	120	77.40
CPF50C	50	2	12	60	115.40
CPF65C	65	2½	4	20	610.00
CPF80C	80	3	2	6	910.00
CPF100C	100	4	1	4	1320.00
ELBOW					
CPF15E	15	½	100	500	12.70
CPF20E	20	¾	100	400	16.00
CPF25E	25	1	50	200	36.10
CPF32E	32	1¼	25	125	70.10
CPF40E	40	1½	15	75	128.90
CPF50E	50	2	8	40	289.50
CPF65E	65	2½	2	6	810.00
CPF80E	80	3	1	4	1350.00
CPF100E	100	4	1	3	2050.00
TEE					
CPF15T	15	½	100	400	17.00
CPF20T	20	¾	50	300	27.00
CPF25T	25	1	30	150	47.50
CPF32T	32	1¼	15	90	89.40
CPF40T	40	1½	10	50	169.60
CPF50T	50	2	5	25	373.10
CPF65T	65	2½	2	6	1401.00
CPF80T	80	3	2	4	2050.00
CPF100T	100	4	1	2	3150.00

CAT NO.	STD. SIZE (mm)	STD. SIZE (Inch)	STD. PACK	STD. PACK	RATE (pc)
ELBOW 45°					
CPF1545E	15	½	50	400	16.35
CPF2045E	20	¾	50	250	27.40
CPF2545E	25	1	25	125	44.50
CPF3245E	32	1¼	10	50	84.50
CPF4045E	40	1½	5	25	133.60
CPF5045E	50	2	5	25	257.10
MALE THREAD ADAPTOR					
CPF15M	15	½	100	800	12.90
CPF20M	20	¾	100	600	22.50
CPF25M	25	1	50	350	34.50
CPF32M	32	1¼	10	50	61.50
CPF40M	40	1½	10	50	84.30
CPF50M	50	2	10	50	160.50
FEMALE THREAD ADAPTOR					
CPF15F	15	½	50	400	13.70
CPF20F	20	¾	100	500	29.50
CPF25F	25	1	50	250	42.50
CPF32F	32	1¼	10	50	81.80
CPF40F	40	1½	10	50	130.10
CPF50F	50	2	5	25	205.10
CPF2015F	20x15	¾ x ½	100	400	31.50
END CAP					
CPF15EC	15	½	100	1500	6.60
CPF20EC	20	¾	100	1000	12.50
CPF25EC	25	1	100	600	20.50
CPF32EC	32	1¼	25	125	46.10
CPF40EC	40	1½	15	75	75.10
CPF50EC	50	2	5	25	135.10
CPF65EC	65	2½	2	10	410.00

C-PVC PIPING SYSTEM

For Hot & Cold Water Management System

CAT NO. CODE	STD. SIZE (mm) (Inch)	STD. PACK Pack Box	RATE (pc)
REDUCER COUPLER			
CPF2015RC	20x15 3/4x1/2	100 500	12.50
CPF2515RC	25x15 1x1/2	100 500	22.10
CPF2520RC	25x20 1x3/4	100 400	29.00
CPF3215RC	32x15 1 1/4x1/2	10 50	41.50
CPF3220RC	32x20 1 1/4x3/4	10 50	44.50
CPF3225RC	32x25 1 1/4x1	10 50	47.50
CPF4015RC	40x15 1 1/2x1/2	10 50	56.50
CPF4020RC	40x20 1 1/2x3/4	10 50	58.50
CPF4025RC	40x25 1 1/2x1	10 50	71.00
CPF4032RC	40x32 1 1/2x1 1/4	10 50	84.00
CPF5015RC	50x15 2x1/2	5 25	111.20
CPF5020RC	50x20 2x3/4	5 25	126.10
CPF5025RC	50x25 2x1	5 25	147.20
CPF5032RC	50x32 2x1 1/4	5 25	163.70
CPF5040RC	50x40 2x1 1/2	5 25	220.10
REDUCER TEE			
CPF2015RT	20x20x15 3/4x3/4x1/2	50 200	38.40
CPF2515RT	25x25x15 1x1x1/2	50 200	49.50
CPF2520RT	25x25x20 1x1x3/4	30 150	70.50
CPF3215RT	32x32x15 1 1/4x1 1/4x1/2	10 50	91.50
CPF3220RT	32x32x20 1 1/4x1 1/4x3/4	10 50	99.50
CPF3225RT	32x32x25 1 1/4x1 1/4x1	10 50	113.50
CPF4015RT	40x40x15 1 1/2x1 1/2x1/2	10 50	136.10
CPF4020RT	40x40x20 1 1/2x1 1/2x3/4	10 50	157.10
CPF4025RT	40x40x25 1 1/2x1 1/2x1	10 50	157.10
CPF4032RT	40x40x32 1 1/2x1 1/2x1 1/4	10 50	181.10
CPF5015RT	50x50x15 2x2x1/2	5 25	264.00
CPF5020RT	50x50x20 2x2x3/4	5 25	291.00
CPF5025RT	50x50x25 2x2x1	5 25	310.00
CPF5032RT	50x50x32 2x2x1 1/4	5 25	319.00
CPF5040RT	50x50x40 2x2x1 1/2	5 25	337.00
REDUCER BUSHING			
CPF2015RB	20x15 3/4 x 1/2	100 800	9.00
CPF2515RB	25x15 1 x 1/2	100 800	16.00
CPF2520RB	25x20 1 x 3/4	100 700	16.50
CPF3215RB	32x15 1 1/4 x 1/2	25 125	37.10
CPF3220RB	32x20 1 1/4 x 3/4	25 125	29.10
CPF3225RB	32x25 1 1/4 x 1	25 125	36.20
CPF4015RB	40x15 1 1/2 x 1/2	10 50	61.10
CPF4020RB	40x20 1 1/2 x 3/4	10 50	65.20
CPF4025RB	40x25 1 1/2 x 1	10 50	68.10
CPF4032RB	40x32 1 1/2 x 1 1/4	10 50	71.50
CPF5015RB	50x15 2 x 1/2	10 30	77.60
CPF5020RB	50x20 2 x 3/4	10 30	99.50
CPF5025RB	50x25 2 x 1	10 30	110.50
CPF5032RB	50x32 2 x 1 1/4	10 30	140.20
CPF5040RB	50x40 2 x 1 1/2	10 30	144.10

CAT NO. CODE	STD. SIZE (mm) (Inch)	STD. PACK Pack Box	RATE (pc)
REDUCER ELBOW			
CPF2015RE	20x15 3/4x1/2	100 600	42.50
CPVC2520RE	25x20 1x3/4	50 250	52.50
REDUCER MTA			
CPF2015RM	20x15 3/4x1/2	100 400	22.50
CPF2515RM	25x15 1x1/2	50 250	27.30
CPF2520RM	25x20 1x3/4	50 300	29.10
TRANSITION BUSHING			
CPF15TB	15x15 1/2x1/2	100 500	10.50
CPF20TB	20x20 3/4x3/4	50 300	15.10
CPF25TB	25x25 1x1	25 150	22.60
CPF32TB	32x32 1 1/4x1 1/4	15 90	36.10
CPF40TB	40x40 1 1/2x1 1/2	10 50	42.60
CPF50TB	50x50 2x2	10 50	77.50
UNION			
CPF15U	15 1/2	50 250	49.50
CPF20U	20 3/4	30 240	92.10
CPF25U	25 1	30 150	120.50
CPF32U	32 1 1/4	5 25	153.50
CPF40U	40 1 1/2	5 25	264.20
CPF50U	50 2	2 10	501.10
CROSS TEE			
CPF15CT	15 1/2	100 300	29.50
CPF20CT	20 3/4	50 150	58.50
CPF25CT	25 1	25 75	94.50
CPF32CT	32 1 1/4	2 10	240.10
CPF40CT	40 1 1/2	2 10	390.20
CPF50CT	50 2	2 10	750.10
STEP OVER BEND			
CPF15SB	15 1/2	30 150	63.00
CPF20SB	20 3/4	20 120	78.10
CPF25SB	25 1	10 50	148.20
BRASS ELBOW			
CPF15BE	15x15 1/2x1/2	25 125	65.20
CPF20BE	20x20 3/4x3/4	25 125	94.50
CPF25BE	25x25 1x1	10 50	390.00
BRASS ELBOW - WALL MOUNTING			
CPF15BEW	15x15 1/2x1/2	50 250	75.10
CPF20BEW	20x20 3/4x3/4	25 125	120.50
CPF25BEW	25x25 1x1	15 60	320.10
BRASS TEE			
CPF15BT	15x15x15 1/2x1/2x1/2	25 100	70.15
CPF20BT	20x20x20 3/4x3/4x3/4	25 100	109.10
CPF25BT	25x25x25 1x1x1	5 25	290.10

C-PVC PIPING SYSTEM

For Hot & Cold Water Management System



CAT NO. CODE	STD. SIZE (mm) (Inch)	STD. PACK		RATE (pc)
		Pack	Box	
BRASS MTA				
CPF15BM	15 1/2	50	200	136.10
CPF20BM	20 3/4	50	200	164.10
CPF25BM	25 1	30	150	260.00
CPF32BM	32 1 1/4	5	25	590.10
CPF40BM	40 1 1/2	5	25	750.20
CPF50BM	50 2	2	10	1310.00
BRASS FTA				
CPF15BF	15 1/2	50	200	93.90
CPF20BF	20 3/4	50	200	180.00
CPF25BF	25 1	30	150	254.00
CPF32BF	32 1 1/4	5	25	560.10
CPF40BF	40 1 1/2	5	25	690.10
CPF50BF	50 2	2	10	1250.00
BRASS R - ELBOW				
CPF2015RBE	20X15 3/4x1/2	50	350	58.00
CPF2515RBE	25x15 1x1/2	50	250	109.30
CPF2520RBE	25X20 1x3/4	10	50	190.50
BRASS R- ELBOW - WALL MOUNTING				
CPF2015RBEW	20X15 3/4x1/2	5	25	80.60
BRASS R - TEE				
CPF2015RBT	20x20x15 3/4x1/2	50	250	81.20
CPF2515RBT	25x25x15 1x1/2	30	150	130.00
CPF2520RBT	25x25x20 1x3/4	10	50	141.20
BRASS R - MTA				
CPF1520RBM	15x20 1/2x3/4	50	400	105.00
CPF2015RBM	20x15 3/4x1/2	50	400	107.30
CPF2515RBM	25x15 1x1/2	30	150	190.20
CPF2520RBM	25x20 1x3/4	20	100	210.60
BRASS R - FTA				
CPVC1520RBF	15x20 1/2x3/4	25	125	77.50
CPF2015RBF	20x15 3/4x1/2	50	350	79.10
CPF2515RBF	25x15 1x1/2	30	150	125.10
CPF2520RBF	25x20 1x3/4	10	50	138.20
TANK NIPPLE				
CPF15TN	15 1/2	30	240	54.50
CPF20TN	20 3/4	30	240	58.50
CPF25TN	25 1	30	150	88.30
CPF32TN	32 1 1/4	5	25	158.30
CPF40TN	40 1 1/2	5	25	210.00
CPF50TN	50 2	5	25	350.00

CAT NO. CODE	STD. SIZE (mm) (Inch)	STD. PACK		RATE (pc)
		Pack	Box	
END PLUG				
CPF15EP	15 1/2	100	1000	13.00
CPF15EPL	15 1/2	100	1000	11.00
CPF15LPL	15 1/2	100	1000	9.50
POWDER COATED METAL STRAP				
CPF15MS	15 1/2	100	1000	6.50
CPF20MS	20 3/4	100	1000	7.40
CPF25MS	25 1	100	1000	8.10
CPF32MS	32 1 1/4	50	500	9.50
CPF40MS	40 1 1/2	50	500	11.10
CPF50MS	50 2	50	500	12.90
BALL VALVE				
CPF15BVI	15 1/2	18	90	112.50
CPF20BVI	20 3/4	12	72	210.00
CPF25BVI	25 1	9	54	295.00
CPF32BVI	32 1 1/4	6	30	453.00
CPF40BVI	40 1 1/2	3	15	920.00
CPF50BVI	50 2	2	10	1310.00
TAFLOX TAPE				
CPF15TT	15 1/2	100	1000	24.00
CPF15TTL	15 1/2	100	1000	20.00
CPF15TTVL	15 1/2	100	1000	16.00

CPVC SOLVENT CEMENT

CAT NO. CODE	STD. SIZE (ml)	STD. PACK		RATE (pc)
		Box	Box	
CPVC SOLVENT CEMENT (TIN PACKING)				
CPSL59	59 ml	48	288	139.00
CPSL118	118 ml	24	144	216.00
CPSL237	237 ml	12	72	355.00
CPSL473	473 ml	6	36	585.00
CPSL946	946 ml	3	18	1065.00

BAJAJ Sewerage Waste Rainwater (SWR) Pipes & Fittings drainage system is designed for quick and efficient removal of waste without leakage. It is highly resilient, tough and durable with high tensile and impact strength. Moreover it is free from scale formation, rusting, weathering and chemical action. It is virtually immune to attack from bacteria, fungi, micro-organisms and insects. Thus, the system is a long term solution for building drainage with estimated life over 50 years. In addition to the various benefits, it is more cost effective than any conventional drainage system.

These pipes & fittings are tough and durable with high tensile and impact strength and are manufactured in accordance to IS:13592 - 1992 & fittings to IS:14735-1999.

Product Range

Pipes - 50 to 160mm sizes as per IS 13592

Fittings- 75 to 110mm sizes as per IS 14735

FEATURES AND BENEFITS

High quality and wide range - The system consists of pipes and a wide range of fittings with various traps, which makes the system complete in all respect and hence customer need not to depend on conventional systems.

Strong and long lasting - This system is highly resilient, tough and durable with high tensile strength and high impact strength. Moreover it is free from problems caused by scale formation, rusting, weathering and chemical action and hence it lasts for a lifetime.

UV resistance - It eliminates the adverse effect of sunlight and weather and can safely used for outdoor installations.

Quick and convenient installation - Being extremely light in weight and provided with special rubber jointing technique, installation of this system becomes very easy.

Quick and efficient removal of waste without leakage - Mirror smooth and restriction free inner surface of pipes and fittings ensures superior flow characteristics making the system free from problems of clogging and drain choke-up. System is completely leak-proof and designed to maintain high standards of hygiene.

Adequate and easy access for cleaning and clearing obstructions.

Low maintenance - Once installed Supreme S.W.R. drainage system need minimal maintenance.

Cost effective - Supreme S.W.R. drainage system is more cost effective than any other conventional drainage system.

DIMENSIONS FOR SWR PIPES

Nominal Diameter	Mean Outside Diameter		Outside Diameter at Any Point		Wall Thickness			
					Type A		Type B	
DN	Min	Max	Min	Max	Min	Max	Min	Max
75 mm	75.00	75.30	74.10	75.90	1.80	2.20	3.20	3.80
110 mm	110.00	110.40	108.60	111.40	2.20	2.70	3.20	3.80
160 mm	160.00	160.50	158.00	162.00	3.20	3.80	4.00	4.60

PRODUCT CODE	SIZE (mm)	STD. LENGTH (feet)	RATE PER PIPE
TYPE - A			
SWR75A20SSP	75	20	864.00
SWR75A10SSP	75	10	432.60
SWR75A10DSP	75	10	452.10
SWR75A6SSP	75	6	259.00
SWR75A6DSP	75	6	269.00
SWR75A4DSP	75	4	172.00
SWR75A3DSP	75	3	130.00
SWR75A2DSP	75	2	86.40
SWR110A20SP	110	20	1680.00
SWR110A10SP	110	10	840.00
SWR110A10DP	110	10	860.00
SWR110A6SSP	110	6	504.00
SWR110A6DSP	110	6	514.00
SWR110A4DSP	110	4	336.00
SWR110A3DSP	110	3	252.00
SWR110A2DSP	110	2	168.00
SWR160A20SP	160	20	3663.00
SWR160A10SP	160	10	1824.00
SWR160A10DP	160	10	1844.00
SEWERAGE PIPES (2.5 Kgf/cm²)			
SEW7510SSP	75	10	360.00
SEW11010SSP	110	10	600.00



PRODUCT CODE	SIZE (mm)	STD. LENGTH (feet)	RATE PER PIPE
TYPE - B			
SWR75B20SSP	75	20	1320.00
SWR75B10SSP	75	10	660.00
SWR75B10DSP	75	10	680.00
SWR75B6SSP	75	6	396.00
SWR75B6DSP	75	6	406.00
SWR75B4DSP	75	4	264.00
SWR75B3DSP	75	3	198.00
SWR75B2DSP	75	2	132.00
SWR110B20SP	110	20	2640.00
SWR110B10SP	110	10	1320.00
SWR110B10DP	110	10	1340.00
SWR110B6SSP	110	6	792.00
SWR110B6DSP	110	6	812.00
SWR110B4DSP	110	4	528.00
SWR110B3DSP	110	3	396.00
SWR110B2DSP	110	2	264.00
SWR160B20SP	160	20	4970.00
SWR160B10SP	160	10	2485.00
SWR160B10DP	160	10	2510.00
SELFIT PIPES (6 Kgf/cm²)			
SWR40620P	40	20	457.00
SWR40610SSP	40	10	228.00
SWR50620P	50	20	710.00
SWR50610SSP	50	10	355.00

PRODUCT CODE	SIZE (mm)	STD. PACK (pc/Cartron)	RATE (pc)
COUPLER			
SWR75CP	75	86	56.30
SWR110CRP	110	68	85.75
BEND 87.50			
SWR75BP	75	60	71.00
SWR110BP	110	40	159.00
BEND 87.50 (DOOR)			
SWR75BDP	75	48	93.00
SWR110BDP	110	32	199.00
SHOE BEND 45			
SWR75SBP	75	92	63.70
SWR110SBP	110	52	115.70

PRODUCT CODE	SIZE (mm)	STD. PACK (pc/Cartron)	RATE (pc)
DOUBLE TEE (DOOR)			
SWR75TDP	75	20	129.00
SWR110TDP	110	10	260.10
SINGLE Y			
SWR75YP	75	30	122.50
SWR110YP	110	20	285.00
SINGLE Y (DOOR)			
SWR75YDP	75	30	148.90
SWR110YDP	110	16	318.50
REDUCER COUPLER			
SWR11075RCP	110X75	60	88.20

SINGLE TEE				
	SWR75TP	75	72	100.40
	SWR110TP	110	24	208.25
SINGLE TEE (DOOR)				
	SWR75TDP	75	50	132.30
	SWR110TDP	110	24	249.50
DOUBLE TEE				
	SWR75TTP	75	45	109.00
	SWR110TTP	110	16	240.10
PIPE CLIP				
	SWR75PC	75	650	20.00
	SWR110PC	110	350	25.00
VENT COWL				
	SWR75VC	75	275	24.50
	SWR110VC	110	130	46.50
NAHANI TRAP (W/O Jali)				
	SWR11075NT	110x75	34	151.20
	SWR11090NT	110x90	34	170.50
	SWR110110NT	110x110	34	185.90
MULTI FLOOR TRAP (W/O Sq Jali)				
	SWR110MFT	110	10	174.00
ROUND JALI				
	SWR110NTJ	110	225	20.60
SQUARE JALI				
	SWR110MTJ	160x160	40	47.20

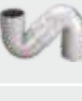
REDUCING SINGLE TEE				
	SWR11075RTP	110X75	28	196.00
REDUCING SINGLE TEE (DOOR)				
	SWR11075TDP	110X75	20	230.40
CLEANSING PIPE				
	SWR75CPP	75	82	85.70
	SWR110CPP	110	30	200.90
P - TRAP				
	SWR110110PT	110x110	17	347.90
	SWR125110PT	125x110	17	365.00
Q - TRAP				
	SWR110110QT	110x110	15	392.00
	SWR125110QT	125x110	15	411.00
S - TRAP				
	SWR110110ST	110x110	12	475.00
	SWR125110ST	125x110	12	509.90
DOOR CAP				
	SWR75DC	75	200	34.30
	SWR110DC	110	125	41.65

PVC SOLVENT CEMENT

CAT NO. CODE	STD. SIZE (ml)	STD. PACK Box	STD. PACK Box	RATE (pc)
PVC SOLVENT CEMENT (TIN PACKING)				
PVCSL59	59 ml	48	288	58.50
PVCSL118	118 ml	24	144	97.20
PVCSL237	237 ml	12	72	183.15
PVCSL473	473 ml	6	36	326.00
PVCSL946	946 ml	3	18	590.00



 **BAJAJ Agriculture PVC Pipe & Fittings Offers** an Exhaustive range of uPVC Pressure pipes and fittings, pressure pipes are manufactured in different pressure classes. These pipes are superior to CI, DI or RCC pipes in terms of being light in weight, easy and quick installation, excellent corrosion and chemical resistance and quick installation, high flow rates, long life and economy.

Product Range

Pipes - 20 to 225mm as per IS:4985 in 2.5 to 10 kgf/cm² pressure classes

Fittings - 20 to 110mm as per IS:7834

Fields of Application

These pipes and fittings are used for a variety of applications like, irrigation, water supply, industrial process lines, swimming pools, firefighting mains, etc.

PRODUCT CODE	STD. SIZE (mm)	RATE (Per Pipe) 6 Mtr.
CLASS 1 / 2.5 KG/CM²		
SELF90CL1	90	840.00
SELF110CL1	110	1296.00
SELF140CL1	140	2006.00
SELF160CL1	160	2600.00
SELF180CL1	180	3273.00
SELF200CL1	200	4310.00
SELF225CL1	225	4704.00
CLASS 2 / 4 Kg/CM²		
SELF63CL2	63	676.00
SELF75CL2	75	916.00
SELF90CL2	90	1320.00
SELF110CL2	110	1872.00
SELF140CL2	140	3110.00
SELF160CL2	160	4195.00
SELF180CL2	180	4972.80
SELF200CL2	200	6970.00
SELF225CL2	225	7120.00
SELF250CL2	250	9050.00

PRODUCT CODE	STD. SIZE (mm)	RATE (mtr)
CLASS 3 / 6 KGF/CM²		
SELF40CL3	40	390.00
SELF50CL3	50	580.00
SELF63CL3	63	950.00
SELF75CL3	75	1370.00
SELF90CL3	90	1870.00
SELF110CL3	110	3240.00
SELF140CL3	140	4370.00
SELF160CL3	160	6210.00
SELF180CL3	180	7520.00
SELF200CL3	200	9720.00
SELF225CL3	225	11500.00
SELF250CL3	250	14100.00
CLASS 5 / 10 KGF/CM²		
SELF63CL5	63	1350.00
SELF75CL5	75	1930.00
SELF90CL5	90	2630.00
SELF110CL5	110	4100.00
SELF140CL5	140	6900.00
SELF160CL5	160	8200.00
SELF180CL5	180	11500.00
SELF200CL5	200	13700.00
SELF225CL5	225	16500.00
SELF250CL5	250	20100.00



PRODUCT CODE	STD. SIZE (mm)	STD. PACK (pc/Box)	RATE (pc)
COUPLER			
PMIC206	20	140	6.00
PMIC256	25	120	9.00
PMIC326	32	120	12.00
PMIC406	40	120	20.00
PMIC506	50	120	23.00
PMIC636	63	100	27.00
PMIC756	75	80	39.30
PMIC906	90	45	56.90
PMIC1106	110	60	86.46
ELBOW			
PMIE206	20	140	9.00
PMIE256	25	120	13.50
PMIE326	32	120	23.10
PMIE406	40	120	26.10
PMIE506	50	120	35.10
PMIE636	63	128	40.80
PMIE756	75	90	52.20
PMIE906	90	60	68.38
PMIE1106	110	36	118.50
PMIE1406	140	16	285.00
PMIE1606	160	8	405.00
FEMALE THREAD ADAPTOR			
PFTA206	20	140	7.00
PFTA256	25	130	9.00
PFTA326	32	130	12.50
PFTA406	40	130	20.10
PFTA506	50	130	25.60
PFTA636	63	120	42.60
PFTA756	75	70	60.10
PFTA906	90	40	90.30
PFTA1106	110	20	157.30
END CAP			
PMEC206	20	160	5.70
PMEC256	25	160	7.10
PMEC326	32	150	9.30
PMEC406	40	150	15.40
PMEC506	50	140	19.50
PMEC636	63	128	24.10
PMEC756	75	90	38.90
PMEC906	90	60	57.90
PMEC1106	110	36	71.50
REDUCER BUSH			
PMRB2520	25x20	140	5.70
PMRB3225	32x25	120	8.10
PMRB3220	32x20	120	11.10
PMRB6340	63x40	110	31.50
PMRB6350	63x50	100	36.00
PMRB9063	90x63	90	51.00
PMRB9075	90x75	60	51.00
PMRB11075	110x75	36	86.00
PMRB11090	110x90	24	72.00

PRODUCT CODE	STD. SIZE (mm)	STD. PACK (pc/Box)	RATE (pc)
TEE			
PMIT206	20	140	9.00
PMIT256	25	120	13.00
PMIT326	32	120	22.00
PMIT406	40	120	28.00
PMIT506	50	120	45.00
PMIT636	63	108	53.00
PMIT756	75	75	68.70
PMIT906	90	40	96.28
PMIT1106	110	24	167.00
PMIT1406	140	12	470.00
PMIT1606	160	6	555.00
MALE THREAD ADAPTOR			
PMTA206	20	140	7.50
PMTA256	25	120	8.00
PMTA326	32	120	11.00
PMTA406	40	120	16.00
PMTA506	50	120	21.00
PMTA636	63	90	37.50
PMTA756	75	60	45.10
PMTA906	90	40	85.30
PMTA1106	110	24	105.00
REDUCER COUPLER			
PMIR 7563	75x63	60	48.00
PMIR 9063	90x63	36	51.00
PMIR 9075	90x75	36	51.00
PMIR 11063	110x63	24	82.00
PMIR 11075	110x75	24	86.00
PMIR 11090	110x90	24	102.00
REDUCER TEE			
PMRT2520	20x20	60	17.60
PMRT3220	32x20	40	32.25
PMRT3225	32x25	30	29.25
PMRT6340	63x40	20	122.00
PMRT11075	110x75	20	318.00
PMRT110X90	110x90	20	330.00

PVC SOLVENT CEMENT

CAT NO. CODE	STD. SIZE (ml)	STD. PACK Box	STD. PACK Box	RATE (pc)
PVC SOLVENT CEMENT (TIN PACKING)				
PVCSL59	59 ml	48	288	58.50
PVCSL118	118 ml	24	144	97.20
PVCSL237	237 ml	12	72	183.15
PVCSL473	473 ml	6	36	326.00
PVCSL946	946 ml	3	18	590.00

BAJAJ Plumbing System is an economical solution that is suitable for a wide variety of applications that involve transportation and distribution of potable water. This hygienic and cost effective system is not only technically superior to conventional GI piping systems but offers many additional advantages over them. It is easy to install and functionally the most suitable system for piping applications like terrace looping, down-take and up-take lines.

Product Range

Pipes - 15 to 1100 (½" to 4") sizes in SCH 40 and SCH 80 Pressure class as per ASTM D-1785

Fittings - 15 to 63mm (½" to 2") sizes in SCH 80 as per ASTM D-2467

FEATURES AND BENEFITS

Strong, resilient and long lasting - This system is highly resilient, tough and durable with high tensile and impact strength. It is also free from weaknesses caused due to rusting, weathering and chemical actions which helps it last considerably longer than GI pipe system.

Light weight - Being light in weight (1/6th the weight of metal piping), these pipes are easy to handle, transport and install.

Overall economy - Maintenance free, long life of a product which is light, can be cut, jointed and installed with little effort saves a huge amount of money over its life time.

Simple and leak proof joints - Jointing can be done speedily with the special solvent cement supplied by the company which ensures 100% leak proof joints.

Most suitable for carrying potable water - Being non-metallic and made from some special compounds, this system is free from corrosion, chemical reactivity and biological effects. Hence most suitable for potable water transportation.

Maintenance free - Being free from all the demerits of old systems like rusting, pitting, scaling, galvanic or electrolytic corrosion, the Supreme aqua Gold system can rightly boast of being maintenance free.

ASTM D 1785 / SCH 40 PIPES

N.B.Size		Nominal	Wall Thickness		Pressure Rating at 23C °
Inch	mm	OD mm	Min	Max	Kg/cm ²
½	15	21.24	2.77	3.28	41.4
¾	20	26.57	2.87	3.38	33.1
1	25	33.27	3.38	3.89	31.0
1¼	32	42.03	3.56	4.07	25.5
1½	40	48.11	3.68	4.19	22.8
2	50	60.17	3.91	4.42	19.3
2½	65	73.02	5.16	5.77	21.10
3	80	88.9	5.49	6.17	18.28
4	100	114.3	6.02	6.73	15.47

ASTM D 1785 / SCH 80 PIPES

N.B.Size		Nominal	Wall Thickness		Pressure Rating at 23C °
Inch	mm	OD mm	Min	Max	Kg/cm ²
½	15	21.24	3.73	4.24	58.6
¾	20	26.57	3.91	4.42	47.6
1	25	33.27	4.55	5.08	43.4
1¼	32	42.03	4.85	5.43	35.9
1½	40	48.11	5.08	5.69	32.4
2	50	60.17	5.54	6.20	27.6
2½	65	73.02	7.01	7.85	29.54
3	80	88.9	7.62	8.53	26.02
4	100	114.3	8.56	9.58	22.50

UPVC PIPES AS PER ASTM D 1785

PRODUCT CODE	N.B. SIZE (mm) (Inch)	STD. PACK (3mtrs / 6mtrs)	RATE (mtr)	RATE (3mtrs / pc)	RATE (6mtrs / pc)	PRODUCT CODE	N.B. SIZE (mm) (Inch)	STD. PACK (3mtrs / 6mtrs)	RATE (mtr)	RATE (3mtrs / pc)	RATE (6mtrs / pc)
ASTM D 1785 / SCH 40 PIPES						ASTM D 1785 / SCH 80 PIPES					
ASTM 4015	15 ½	50 / 30	61.50	184.50	369.00	ASTM 8015	15 ½	50 / 30	73.50	220.50	441.00
ASTM 4020	20 ¾	40 / 25	76.50	229.50	459.00	ASTM 8020	20 ¾	40 / 25	106.00	318.00	636.00
ASTM 4025	25 1	25 / 20	123.00	369.00	738.00	ASTM 8025	25 1	25 / 20	147.00	441.00	882.00
ASTM 4032	32 1¼	15 / 10	159.00	477.00	954.00	ASTM 8032	32 1¼	15 / 10	204.00	612.00	1224.00
ASTM 4040	40 1½	10 / 10	196.00	588.00	1176.00	ASTM 8040	40 1½	10 / 10	246.00	738.00	1476.00
ASTM 4050	50 2	6 / 5	246.00	738.00	1476.00	ASTM 8050	50 2	6 / 5	327.00	981.00	1962.00
ASTM 4065	65 2½	5 / 5	463.00	1389.00	2778.00	ASTM 8065	65 2½	5 / 5	615.00	1845.00	3690.00
ASTM 4080	80 3	3 / 3	615.00	1845.00	3690.00	ASTM 8080	80 3	3 / 3	825.00	2475.00	4950.00
ASTM 40100	100 4	2 / 2	885.00	2655.00	5310.00	ASTM 80100	100 4	2 / 2	1200.00	3600.00	7200.00

UPVC FITTINGS AS PER ASTM D 2467 / SCH 80

PRODUCT CODE	STD. SIZE (mm) (Inch)		STD. PACK Bag Carton		RATE (pc)	PRODUCT CODE	STD. SIZE (mm) (Inch)		STD. PACK Bag Carton		RATE (pc)
	(mm)	(Inch)	Bag	Carton			(mm)	(Inch)	Bag	Carton	
COUPLER						ELBOW 45°					
ASTM 15C	15	½	100	500	11.00	ASTM1545E	15	½	50	250	14.60
ASTM 20C	20	¾	50	350	16.00	ASTM2045E	20	¾	25	150	25.40
ASTM 25C	25	1	50	200	25.20	ASTM2545E	25	1	25	125	37.10
ASTM 32C	32	1¼	10	100	35.20	ASTM3245E	32	1¼	10	100	50.10
ASTM 40C	40	1½	10	100	47.30	ASTM4045E	40	1½	10	80	68.10
ASTM 50C	50	2	5	60	74.10	ASTM5045E	50	2	5	45	95.10
ELBOW						MALE THREAD ADAPTOR					
ASTM15E	15	½	100	400	12.00	ASTM 15M	15	½	100	700	10.50
ASTM20E	20	¾	50	250	20.70	ASTM 20M	20	¾	50	300	13.20
ASTM25E	25	1	50	100	32.20	ASTM 25M	25	1	50	250	21.20
ASTM32E	32	1¼	10	80	59.60	ASTM 32M	32	1¼	10	200	31.40
ASTM40E	40	1½	10	50	69.90	ASTM 40M	40	1½	10	160	43.10
ASTM50E	50	2	5	35	116.50	ASTM 50M	50	2	5	100	57.50
TEE						FEMALE THREAD ADAPTOR					
ASTM15T	15	½	50	250	19.90	ASTM 15F	15	½	100	600	12.00
ASTM20T	20	¾	30	150	27.50	ASTM 20F	20	¾	50	300	15.75
ASTM25T	25	1	30	60	46.70	ASTM 25F	25	1	50	200	24.10
ASTM32T	32	1¼	10	50	71.30	ASTM 32F	32	1¼	10	140	38.40
ASTM40T	40	1½	5	40	95.20	ASTM 40F	40	1½	10	100	47.00
ASTM50T	50	2	2	24	165.20	ASTM 50F	50	2	5	70	67.50
						END CAP					
						ASTM 15EC	15	½	100	1000	9.50
						ASTM 20EC	20	¾	100	700	12.50
						ASTM 25EC	25	1	100	600	18.50
						ASTM 32EC	32	1¼	10	250	25.20
						ASTM 40EC	40	1½	10	200	33.70
						ASTM 50EC	50	2	5	100	50.10

U-PVC PIPING SYSTEM



For Cold Water PISECing System

PRODUCT CODE	STD. SIZE		STD. PACK		RATE (pc)
	(mm)	(Inch)	Bag	Carton	
REDUCER COUPLER					
ASTM2015RC	20x15	¾x½	50	250	15.20
ASTM2515RC	25x15	1x½	50	250	27.20
ASTM2520RC	25x20	1x¾	25	100	25.50
ASTM3215RC	32x15	1½x½	25	100	34.30
ASTM3220RC	32x20	1½x¾	25	100	36.30
ASTM3225RC	32x25	1½x1	25	100	38.30
ASTM4015RC	40x15	1½x½	10	100	40.40
ASTM4020RC	40x20	1½x¾	10	100	42.50
ASTM4025RC	40x25	1½x1	10	100	45.10
ASTM4032RC	40x32	1½x1¼	10	100	47.10
ASTM5015RC	50x15	2x½	10	70	55.20
ASTM5020RC	50x20	2x¾	10	70	57.10
ASTM5025RC	50x25	2x1	10	70	64.60
ASTM5032RC	50x32	2x1¼	10	70	69.30
ASTM5040RC	50x40	2x1½	5	30	72.10
REDUCER TEE					
ASTM2015RT	20x20x15	¾x¾x½	30	120	29.10
ASTM2515RT	25x25x15	1x1x½	30	120	46.10
ASTM2520RT	25x25x20	1x1x¾	25	100	46.50
ASTM3215RT	32x32x15	1½x1½x½	10	70	69.60
ASTM3220RT	32x32x20	1½x1½x¾	10	70	74.50
ASTM3225RT	32x32x25	1½x1½x1	10	60	76.80
ASTM4015RT	40x40x15	1½x1½x½	5	20	89.30
ASTM4020RT	40x40x20	1½x1½x¾	5	20	91.20
ASTM4025RT	40x40x25	1½x1½x1	5	20	95.60
ASTM4032RT	40x40x32	1½x1½x1¼	5	20	100.30
ASTM5015RT	50x50x15	2x2x½	5	10	145.20
ASTM5020RT	50x50x20	2x2x¾	5	10	147.30
ASTM5025RT	50x50x25	2x2x1	5	10	149.50
ASTM5032RT	50x50x32	2x2x1¼	5	10	153.20
ASTM5040RT	50x50x40	2x2x1½	5	10	156.10
REDUCER BUSHING					
ASTM2015PSC20X15	¾x½		100	1000	9.90
ASTM2515PSC25X15	1x½		100	700	14.10
ASTM2520PSC25X20	1x¾		50	600	16.10
ASTM3225PSC32X25	1½x1		25	300	20.10
ASTM4015PSC40X15	1½x½		10	250	18.80
ASTM4020PSC40X20	1½x¾		10	250	32.60
ASTM4025PSC40X25	1½x1		10	250	34.30
ASTM4032PSC40X32	1½x1¼		10	250	35.60
ASTM5015PSC50X15	2x½		10	120	59.30
ASTM5020PSC50X20	2x¾		10	120	62.50
ASTM5025PSC50X25	2x1		10	120	65.00
ASTM5032PSC50X32	2x1¼		10	120	50.25
ASTM5040PSC50X40	2x1½		10	120	44.50

PRODUCT CODE	SIZE		STD. PACK		RATE (pc)
	(mm)	(Inch)	Bag	Carton	
REDUCER ELBOW					
ASTM2015RE	20x15	¾x½	25	250	22.80
ASTM2515RE	25x15	1x½	50	150	23.10
ASTM2520RE	25x20	1x¾	25	150	38.90
REDUCER MTA					
ASTM2015RM	20x15	¾x½	100	600	20.10
ASTM2515RM	25x15	1x½	100	400	20.50
ASTM2520RM	25x20	1x¾	50	200	30.10
UNION					
ASTM15U	15	½	30	240	44.60
ASTM20U	20	¾	30	150	63.00
ASTM25U	25	1	30	90	95.50
ASTM32U	32	1¼	5	60	116.50
ASTM40U	40	1½	5	50	160.10
ASTM50U	50	2	5	25	187.30
CROSS TEE					
ASTM15CT	15	½	50	200	18.50
ASTM20CT	20	¾	30	120	29.50
ASTM25CT	25	1	20	80	51.30
ASTM32CT	32	1¼	5	45	80.40
ASTM40CT	40	1½	5	30	101.30
ASTM50CT	50	2	5	20	160.10
STEP OVER BEND					
ASTM15SB	15	½	20	120	49.50
ASTM20SB	20	¾	10	50	53.50
ASTM25SB	25	1	5	25	112.10
ELBOW (BRASS)					
ASTM15BE	15X15	½x½	50	300	74.50
ASTM20BE	20X20	¾x¾	20	80	165.00
ASTM25BE	25x25	1x1	10	40	260.10
TEE (BRASS)					
ASTM15BT	15x15x15	½x½x½	50	200	99.50
ASTM20BT	20x20x20	¾x¾x¾	25	75	177.10
ASTM25BT	25x25x25	1x1x1	10	40	325.00
MTA (BRASS)					
ASTM15BM	15	½	50	350	119.90
ASTM20BM	20	¾	30	210	205.00
ASTM25BM	25	1	30	150	290.00
ASTM32BM	32	1¼	10	50	579.00
ASTM40BM	40	1½	10	40	670.00
ASTM50BM	50	2	5	10	920.00
FTA (BRASS)					
ASTM15BF	15	½	50	400	74.50
ASTM20BF	20	¾	30	210	155.00
ASTM25BF	25	1	30	150	220.00
ASTM32BF	32	1¼	10	40	410.00
ASTM40BF	40	1½	5	30	450.00
ASTM50BF	50	2	5	20	753.00

UPVC FITTINGS AS PER ASTM D 2467 / SCH 80

	PRODUCT CODE	STD. SIZE (mm) (Inch)	STD. PACK		RATE (pc)
			Bag	Carton	
R - ELBOW (BRASS)					
	ASTM2015RBE	20x15 ¾x½	25	100	128.00
	ASTM2515RBE	25x15 1x½	25	75	139.50
	ASTM2520RBE	25x20 1x¾	15	75	176.50
R - TEE (BRASS)					
	ASTM2015RBT	20X20x15 ¾x¾x½	10	70	148.20
	ASTM2515RBT	25X25x15 1x1x½	10	40	170.50
	ASTM2520RBT	25X25x20 1x1x¾	10	40	195.60
R-MTA (BRASS)					
	ASTM2015RBM	20X15 ¾x½	10	50	149.20
	ASTM2520RBM	25x20 1x¾	10	30	189.50
R-FTA (BRASS)					
	ASTM1520RBF	15x20 ½x¾	10	50	105.50
	ASTM2015RBF	20x15 ¾x½	10	50	115.10
	ASTM2515RBF	25x15 1x½	10	30	128.10
	ASTM2520RBF	25x20 1x¾	10	30	137.10
TANK NIPPLE					
	ASTM15TN	15 ½	30	300	42.50
	ASTM20TN	20 ¾	30	240	48.50
	ASTM25TN	25 1	30	120	60.50
	ASTM32TN	32 1¼	10	60	75.40
	ASTM40TN	40 1½	10	30	90.60
	ASTM50TN	50 2	10	20	142.50

	PRODUCT CODE	STD. SIZE (mm) (Inch)	STD. PACK		RATE (pc)
			Bag	Carton	
POWDER COATED METAL STRAP					
	ASTM15MS	15 ½	100	1000	6.40
	ASTM20MS	20 ¾	100	1000	7.40
	ASTM25MS	25 1	100	1000	8.60
	ASTM32MS	32 1¼	50	500	10.50
	ASTM40MS	40 1½	50	250	12.90
	ASTM50MS	50 2	50	200	15.10
BALL VALVE					
	ASTM15BVI	15 ½	12	48	110.00
	ASTM20BVI	20 ¾	9	36	125.00
	ASTM25BVI	25 1	9	36	210.00
	ASTM32BVI	32 1¼	6	30	481.00
	ASTM40BVI	40 1½	5	20	735.00
	ASTM50BVI	50 2	4	16	1410.00

ASTM SOLVENT CEMENT

PRODUCT CODE	SIZE (ml)	STD PACK		RATE (pc)
		Box	Carton	
UPVC SOLVENT CEMENT (TIN PACKING)				
ASTM SL59	59ml	48	288	120.00
ASTM SL118	118ml	24	144	185.00
ASTM SL237	237ml	12	72	331.00
ASTM SL473	473ml	6	36	531.00
ASTM SL946	946ml	3	18	810.00

 **BAJAJ Garden Pipes** in the household users partner for life. It is a non-reinforced general purpose tube which comes as transparent. Coloured or plain opaque according to specification. It is available in various sizes (diameter 15 mm to 50 mm) as well as thickness (0.75 mm to 6 mm).

Product Range

1/2" (15mm) to 1 1/2" (50mm)

Fields of Application

- PVC Garden can be used in gardening, general water transportation & water connections etc.
- It can be used for domestic pesticide spraying & water spraying etc.
- It is used as levelling tubes in constructions.
- It ends applications in automobiles and laboratories.

Colours :

Green, Pink, Orange & Purple



GARDEN PIPE

CAT NO.	SIZE (mm)	SIZE (Inch)	STD. PACK	WEIGHT (Per Pc.)	RATE
GP3015	15	1/2	15	4.0 - 4.5	245.00
GP3020	20	3/4	10	6.0 - 6.5	245.00
GP3025	25	1	08	9.0 - 9.5	245.00
GP3032	32	1 1/4	05	12.5 - 13.0	245.00
GP3040	40	1 1/2	03	17.0 - 18.0	245.00

SUCTION HOSE PIPING SYSTEM

For Motor Water Transmission



BAJAJ PVC SUCTION HOSE has a rigid PVC spiral reinforcement between soft walls which makes it an ideal replacement to rubber hoses. It is light in weight and extremely flexible. It can be put to task even at the most demanding curves & bends with absolutely no loss of flexibility. Smooth inside and outside it has an excellent resistance to pressure, external impacts, most of the chemicals, gases, light acids and saline water.

Product range

3/4" (20mm) to 4" (110mm)

Fields of application

- PVC Suction Hose can be used in gardening, general water transportation & water connections etc.
- It can be used for domestic pesticide spraying & water spraying etc.
- It is used as levelling tubes in constructions.
- It ends applications in automobiles and laboratories.

Medium Duty Hose (Green)

Normal Size		I.D.	O.D.	Bending Radius	Working Pressure	Standard Length
Inches	mm	mm	mm	mm	mm	mm
3/4	20	19.0 *	23.6 **	45	7.0	30
1	25	25.0 *	30.0 **	60	7.0	30
1 1/4	30	31.8 *	36.8 **	80	6.5	30
1 1/2	38	38.0 *	43.3 **	110	5.0	30
2	50	50.8 **	57.8 **	130	4.0	30
2 1/2	65	63.5 **	72.0 **	175	4.0	30
3	75	76.2 **	85.0 **	275	3.5	30
4	100	101.2 **	112.2 **	310	3.5	15/30

SUCTION HOSE

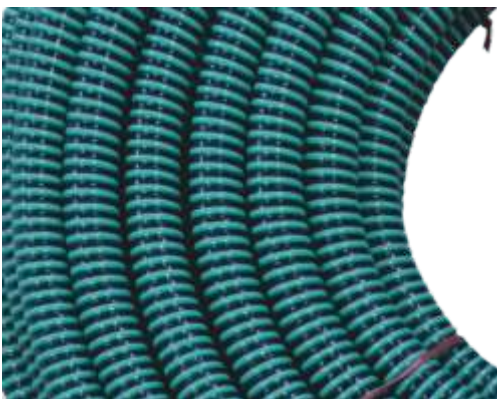

CAT NO.	SIZE (mm)	SIZE (Inch)	STD. PACK	WEIGHT (Per Pc.)	RATE
SHP3025	25	3/4"	10	5.3 - 5.8	285.00
SHP3032	32	1"	10	6.2 - 6.8	285.00
SHP3040	40	1 1/4"	3	10.0 - 11.0	285.00
SHP3050	50	1 1/2"	2	12.0 - 13.0	285.00
SHP3063	63	2"	2	18.0 - 20.0	285.00
SHP3075	75	2 1/2"	1	27.0 - 30.0	285.00
SHP3090	90	3"	1	37.0 - 40.0	285.00
SHP30110	110	4"	1	62.0 - 65.0	285.00

BAJAJ PVC HIGH PRESSURE BRAIDED HOSE Qualified hi-strength lucent fibre-wire, PVC synthesis materials. Clearance and transparent pipe body is easy for controlling the carrying of liquid fux Strong power for felting internal and external layers, is high pressure resistance, non toxic and long life span.

Product range

1/2" (15mm) to 1 1/4" (40mm)

Fields of application

- PVC High Pressure Braided Hose can be used in gardening, general water transportation & water connections etc.
- It can be used for domestic pesticide spraying & water spraying etc.
- It is used as levelling tubes in constructions.
- It ends applications in automobiles and laboratories.
- Adopt qualified PVC synthesis materials and net shaped polyester fibre.
- Light weight, soft, elastic and easy for moving.
- Good durability
- The ideal necessity for various garden irrigation, vehicle washing and daily washing.

BRAIDED HOSE



CAT NO.	SIZE (mm)	SIZE (Inch)	STD. PACK	WEIGHT (Per Pc.)	RATE
BH3020	20	1/2	10	4.0 - 4.5	282.00
BH3025	25	3/4	08	6.0 - 6.5	282.00
BH3032	32	1	05	8.0 - 8.5	282.00
BH3040	40	1 1/4	03	15.0 - 16.0	282.00

 **BAJAJ Medium Density Polyethylene pipe (MDPE)** is light weight, flexible and durable piping system which is manufactured within the world class Quality Management Systems as per ISO 9001-2008. Light weight, Flexible and durable. Crack resistant. Robust construction with high impact strength. Suitable for cold and waste water distribution system. Low friction losses due to excellent smooth internal surface. Resistant to chemical reaction, bacterial growth, corrosion, rusting etc.

Product range

20 mm to 32 mm

Fields of application

- MDPE can be used in gardening, general water transportation & water connections etc.
- It can be used for domestic pesticide spraying & water spraying etc.
- Light weight, soft, elastic and easy for moving.
- Good durability



MDPE PIPES

CAT NO.	SIZE (mm)	SIZE (Inch)	STD. PACK	RATE
MP1020	20	1/2	1	4680.00
MP1025	25	3/4	1	6232.00
MP1032	32	1	1	7479.00

 **BAJAJ Conduit Pipes & Fittings** are Manufactured in Accordance with Bureau of India Standards Specifications IS:9537 (Part-3) in the Range of 20mm to 50mm with Light, Medium and Heavy Range, Thicknesses with the Thin-Wall Variety Only Suitable for Embedded Use in Concrete.

Product Range

3/4" (20mm) to 2" (50mm)

LMS (Light Mechanical Strees)

MMS (Medium Mechanical Strees)

HMS (Heavy Mechanical Strees)

Field of Applications

- Apartments • High Rise Buildings
- Hotels • Hospitals • Shopping Malls
- Parking • Factories

FEATURES & BENEFITS

High Corrosion Resistance

Fire Resistance

Non-Conductor of Electricity

Light Weight

Easy Wiring

Easy Installation

High Mechanical Strength

No Maintenance

Durability

BATCH WISE TESTING BEFORE DISPATCHING

Checking of Dimensions

Compression Test

Collapse Test

Resistance to Burning

Bending Test

Impact Test

Resistance to Heat

Electrical Characteristic

CONDUIT ELECTRICAL PIPING SYSTEM

For Home Purpose Electrical Fittings



CAT NO.	SIZE (mm)	SIZE (Inch)	STD. PACK	RATE (mtr)	RATE (3mtrs / pc)	CAT NO.	SIZE (mm)	SIZE (Inch)	STD. PACK	RATE (mtr)	RATE (3mtrs / pc)	CAT NO.	SIZE (mm)	SIZE (Inch)	STD. PACK	RATE (mtr)	RATE (3mtrs / pc)
LMS (LIGHT MECHANICAL STREES)						MMS (MEDIUM MECHANICAL STREES)						HMS (HEAVY MECHANICAL STREES)					
ECP1120	20	¾	100	25.90	77.70	ECP1120	20	¾	100	29.40	88.20	ECP1120	20	¾	100	34.50	103.50
ECP1125	25	1	50	34.30	102.90	ECP1125	25	1	50	37.50	112.50	ECP1125	25	1	50	40.90	122.70
ECP1132	32	1¼	25	52.50	157.50	ECP1132	32	1¼	25	70.90	212.70	ECP1132	32	1¼	25	89.20	267.60
ECP1140	40	1½	25	88.90	266.70	ECP1140	40	1½	25	96.40	289.20	ECP1140	40	1½	25	117.00	351.00
ECP1150	50	2	25	114.90	344.70	ECP1150	50	2	25	139.90	419.70	ECP1150	50	2	25	175.50	555.50

CAT NO.	STD. SIZE (mm)	STD. SIZE (Inch)	STD. PACK	RATE (pc)	RATE With Screwed Lid/Pcs.
CIRCULAR BOX - TERMINAL (1 WAY)					
ECPF20CB1	20	¾	25	18.15	24.30
ECPF25CB1	25	1	20	23.10	29.10
CIRCULAR BOX - THROUGH (2 WAY)					
ECPF20CB2	20	¾	25	19.50	25.50
ECPF25CB2	25	1	20	23.70	29.70
CIRCULAR BOX - TEE (3 WAY)					
ECPF20CB3	20	¾	25	21.30	27.30
ECPF25CB3	25	1	15	25.80	31.80
CIRCULAR BOX - INTERSECTION (4 WAY)					
ECPF20CB4	20	¾	25	23.40	29.55
ECPF25CB4	25	1	15	30.60	36.00
DEEP CIRCULAR BOX - TERMINAL (1 WAY)					
ECPF20DCB1	20	¾	10	29.40	35.40
ECPF25DCB1	25	1	10	36.60	42.60
DEEP CIRCULAR BOX - THROUGH (2 WAY)					
ECPF20DCB2	20	¾	10	31.50	37.50
ECPF25DCB2	25	1	10	37.90	44.55
DEEP CIRCULAR BOX - TEE (3 WAY)					
ECPF20DCB3	20	¾	10	33.90	40.05
ECPF25DCB3	25	1	10	45.30	51.30
DEEP CIRCULAR BOX - INTERSECTION (4 WAY)					
ECPF20DCB4	20	¾	10	35.25	41.25
ECPF25DCB4	25	1	10	47.10	53.10
CIRCULAR LID					
ECPF65CL	65	2	100	4.80	52.50

CAT NO.	STD. SIZE (mm)	STD. SIZE (Inch)	STD. PACK	RATE (pc)
SLIP TYPE BEND				
ECPF20BEND	20	¾	100	10.50
ECPF25BEND	25	1	100	12.75
ECPF32BEND	32	1¼	50	48.00
ECPF40BEND	40	1½	25	97.50
ECPF50BEND	50	2	20	38.00
COUPLER				
ECPF20C	20	¾	200	5.25
ECPF25C	25	1	100	7.05
ECPF32C	32	1¼	100	12.75
ECPF40C	40	1½	50	21.75
ECPF50C	50	2	25	36.00
SPACE BAR SADDLE				
ECPF20SBS	20	¾	150	7.65
ECPF25SBS	25	1	150	9.30
ROUND ELBOW				
ECPF20RE	20	¾	100	7.35
ECPF25RE	25	1	100	10.40
ROUND TEE				
ECPF20RT	20	¾	100	10.65
ECPF25RT	25	1	50	15.00
WALL PLUG (GITTI)				
ECPF32WP	32mm		50	27.00
ECPF40WP	40mm		50	30.60
FAN SHEET				
ECPF44FS	4x4 inch		80	3.82
ECPF77FS	7x7 inch		50	14.40
ELECTRICAL INSULATION TAPE				
ECPF8EIT	8 mtr.		30	652.00

CLAMPS

For Home Purpose Electrical Accessories



CIRCLE CABLE CLAMPS

DOUBLE NAIL CLAMPS

CAT No.	SIZE (mm)	STD. Packing	RATE (per packet)
DNC20	20 MM	50	194.00
DNC25	25 MM	50	329.00
DNC32	32 MM	50	411.00
DNC40	40 MM	50	575.00

UPVC PIPE FITTING CLAMPS

CAT No.	SIZE (mm)	STD. Packing	RATE (per packet)
UPFC20	U - 1/2	100	408.00
UPFC25	U - 3/4	100	658.00
UPFC32	U - 1	50	435.00
UPFC40	U - 1-1/4	50	575.00

CPVC PIPE FITTING CLAMPS



CAT No.	SIZE (mm)	STD. Packing	RATE (per packet)
CPFC20	U - 3/4	100	422.00
CPFC25	U - 1	100	688.00
CPFC32	U - 1-1/4	50	455.00
CPFC40	U - 1-1/2	25	287.00

	PRODUCT CODE	STANDARD SIZE (mm)	STD. PACKING	RATE (per packet)	STD. BAG PACKING
	CCC4	4 MM	100	30.80	750
	CCC5	5 MM	100	36.40	550
	CCC6	6 MM	100	43.40	450
	CCC7	7 MM	100	50.40	400
	CCC8	8 MM	100	57.40	300
	CCC9	9 MM	100	77.00	220
	CCC10	10 MM	100	81.20	200
	CCC12	12 MM	100	109.20	150
	CCC14	14 MM	100	156.80	100
	CCC16	16 MM	100	165.20	80
	CCC18	18 MM	100	176.40	60
	CCC20	20 MM	100	179.00	50
	CCC25	25 MM	100	218.00	35
	CCCBR	BATTEN ROUND	100	30.80	750
	CCCBF	BATTEN FLAT	100	36.60	700
	CCCBO	BATTEN OVAL	50	29.40	700
	CCC32	32 MM	50	411.60	32
					



UV CABLE TIE & DRY WALL SCREW

For Home Purpose Electrical Accessories

UV CABLE TIE IN NYLON PA66

	PRODUCT CODE	STANDARD SIZE (mm)	STD. PACKING	RATE (per packet)	STD. CARTOON PACKING
	CTN 10018	100*1.8	4	32.10	700
	CTN 10022	100*2.2	4	38.90	600
	CTN 10025	100*2.5	4	46.60	500
	CTN 10022	150*2.2	6	58.20	500
	CTN 10030	150*3.0	6	93.30	300
	CTN 10036	150*3.6	6	114.20	250
	CTN 10025	200*2.5	8	95.80	300
	CTN 10030	200*3.0	8	122.20	250
	CTN 10028	250*2.8	10	143.80	200
	CTN 10036	250*3.6	10	180.60	200
	CTN 10048	250*4.8	10	282.48	140
	CTN 10029	300*2.9	12	187.80	180
	CTN 10033	300*3.3	12	216.50	140
	CTN 10036	300*3.6	12	233.20	160
	CTN 10036	350*3.6	14	286.70	140

DRY WALL SCREW

	PRODUCT CODE	STANDARD SIZE (mm)	STD. PACKING	RATE (per packet)	STD. CARTOON PACKING
	DWS 3519	3.5*19mm	1000 pcs	456.00	20
	DWS 3525	3.5*25mm	1000 pcs	592.00	20
	DWS 3532	3.5*32mm	500 pcs	388.00	20
	DWS 3538	3.5*38mm	500 pcs	440.00	20
	DWS 3550	3.5*50mm	500 pcs	564.00	20
	DWS 3563	3.5*63mm	250 pcs	388.00	20
	DWS 3575	3.5*75mm	250 pcs	456.00	20

HDPE PIPING SYSTEM

For Agriculture Water Transfer



BAJAJ HDPE Roll Coil Has Long Life, Non Corrosive, Low Friction, Weather Resistant, Cost Effective, Light Weight, Easy To Install Repair And Replace, Low Thermal And Electrical Conductive, Non Toxic, Hard And Unbreakable.

Product Range

1" (32mm) to 4" (110mm)

Field Of Applications

- Drinking Water Supply.
- Lifting Water For Agriculture.
- Obtain Water Through Pumps.
- Industrial Disposal Of Chemical Efficient
- Transportation Of Aggressive Fluids Chemical And Acid.

HDPE PIPES PE-63

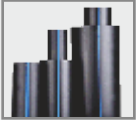

SIZE (Inch)	SIZE (mm)	PN-2.5 Rate/mtr.	PN-4 Rate/mtr.	PN-6 Rate/mtr.	PN-8 Rate/mtr.	PN-10 Rate/mtr.
1"	32	-	-	81.36	101.52	118.80
1¼"	40	-	90.36	122.40	156.24	185.04
1½"	50	-	136.08	190.44	242.28	286.56
2"	63	145.08	210.96	300.24	382.32	449.28
2½"	75	200.52	300.96	428.76	539.64	661.88
3"	90	287.64	430.56	588.24	771.48	913.32
4"	110	426.96	645.12	906.12	1143.72	1373.40

HDPE PIPES PE-80

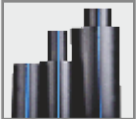

SIZE (Inch)	SIZE (mm)	PN-2.5 Rate/mtr.	PN-4 Rate/mtr.	PN-6 Rate/mtr.	PN-8 Rate/mtr.	PN-10 Rate/mtr.
1"	32	-	-	-	84.24	101.52
1¼"	40	-	-	103.68	129.60	156.24
1½"	50	-	129.60	160.20	204.48	242.28
2"	63	-	180.00	250.20	317.52	382.32
2½"	75	-	245.52	354.96	449.28	539.64
3"	90	241.92	355.32	504.36	642.96	771.48
4"	110	342.72	531.72	756.36	961.56	1143.72

HDPE PIPES PE-100

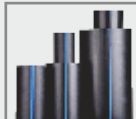

SIZE (Inch)	SIZE (mm)	PN-6 Rate/mtr.	PN-8 Rate/mtr.	PN-10 Rate/mtr.
1"	32	-	-	84.24
1¼"	40	-	107.28	129.60
1½"	50	131.40	164.88	199.80
2"	63	204.48	262.08	317.52
2½"	75	293.76	369.36	449.28
3"	90	412.92	529.92	642.96
4"	110	607.68	787.68	951.48



Model : BABPTMT-3802

Pillar Cock

M.R.P. : ₹ 260/-



Model : BABPTMT-3801
Bib Cock
M.R.P. : ₹ 190/-



Model : BABPTMT-3803
Long Body
M.R.P. : ₹ 220/-



Model : BABPTMT-3808
Angle Cock
M.R.P. : ₹ 190/-



Model : BABPTMT-3804
Bib Cock 2 Way
M.R.P. : ₹ 400/-



Model : BABPTMT-3806
Angle Cock 2 Way
M.R.P. : ₹ 380/-



Model : BABPTMT-3807
Nozzle Cock
M.R.P. : ₹ 210/-



Model : BABPTMT-3805
Push Cock (STD)
M.R.P. : ₹ 140/-



Model : BABPTMT-3818
Stop Cock (F/T)
M.R.P. : ₹ 210/-



Model : BABPTMT-3809
Stop Cock (M/T)
M.R.P. : ₹ 210/-



Model : BABPTMT-3821
Mini Swan Neck
M.R.P. : ₹ 490/-



Model : BABPTMT-3822
Mini Sink Cock
M.R.P. : ₹ 490/-



Model : BABPTMT-3817
Swan Neck (T/M)
M.R.P. : ₹ 550/-



Model : BABPTMT-3810
Sink Cock (W/M)
M.R.P. : ₹ 550/-



Model : BABPTMTF-3901
Pillar Cock
M.R.P. : ₹ 280/-



Model : BABPTMTF-3902
Bib Cock
M.R.P. : ₹ 210/-



Model : BABPTMTF-3903
Long Body
M.R.P. : ₹ 240/-



Model : BABPTMTF-3904
Angle Cock
M.R.P. : ₹ 210/-



Model : BABPTMTF-3905
Bib Cock 2 Way
M.R.P. : ₹ 430/-



Model : BABPTMTF-3906
Angle Cock 2 Way
M.R.P. : ₹ 400/-



Model : BABPTMTF-3907
Nozzle Cock
M.R.P. : ₹ 230/-



Model : BABPTMTF-3908
Stop Cock (F/T)
M.R.P. : ₹ 220/-



Model : BABPTMTF-3909
Stop Cock (M/T)
M.R.P. : ₹ 220/-



Model : BABPTMTF-3910
Mini Swan Neck
M.R.P. : ₹ 490/-



Model : BABPTMTF-3911
Mini Sink Cock
M.R.P. : ₹ 490/-



Model : BABPTMTF-3912
Swan Neck (T/M)
M.R.P. : ₹ 550/-



Model : BABPTMTF-3913
Sink Cock (W/M)
M.R.P. : ₹ 550/-

PVC TAPS & ACCESSORIES

Enjoy Collection



Model : ENJ001
Short Body Bib Cock
₹ 84.00



Model : ENJ002
Long Body Bib Cock
₹ 98.00



Model : ENJ003
Angle Cock
₹ 84.00



Model : ENJ004
Pillar Tap
₹ 110.00



Model : ENJ005
Two Way Bib Cock
₹ 240.00



Model : ENJ006
Swan Neck
₹ 275.00



Model : ENJ007
Sink Cock
₹ 275.00



P.T.M.T. Ball Cock Body (with Epoxy Coated Aluminium Rod & H.D. Ball)

Model : BPTMTBCA-3814 (15 mm) • **M.R.P. :** ₹ 245/-

Model : BPTMTBCA-3815 (20 mm) • **M.R.P. :** ₹ 400/-

Model : BPTMTBCA-3816 (25 mm) • **M.R.P. :** ₹ 865/-



Health Faucet

BPTMTCHF01	1 Mtr.	₹ 465.00
BPTMTCHF02	1.5 Mtr.	₹ 540.00



Collapsible Waste Pipe
BPTMTCWP | ₹ 95.00

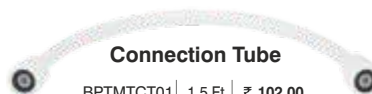

Connection Tube

BPTMTCT01	1.5 Ft.	₹ 102.00
BPTMTCT02	2 Ft.	₹ 124.00
BPTMTCT03	2.5 Ft.	₹ 170.00
BPTMTCT04	3 Ft.	₹ 210.00
BPTMTCT05	3.5 Ft.	₹ 260.00

FLUSHING CISTERNS

Collection



Anti-Bacterial
Germ-Free Protection



Long Lasting
Maintenance Free



Save
Water



Efficient Flushing
Mechanism



Eco
Friendly



DOLPHIN

SINGLE FLUSH

Model : BFC-01

Capacity : 10 Ltrs

M.R.P. : ` 1320/-

Available Colour :  

FLUSHING CISTERNS

Collection



Anti-Bacterial
Germ-Free Protection



Long Lasting
Maintenance Free



Save
Water



Efficient Flushing
Mechanism



Eco
Friendly

ANSHUL

SINGLE FLUSH

Model : BFC-02

Capacity : 10 Ltrs

M.R.P. : ₹ 1180/-

Available Colour :



ANMOL

SINGLE FLUSH

Model : BFC-03

Capacity : 10 Ltrs

M.R.P. : ₹ 1015/-

Available Colour :



FLUSHING CISTERNS

Collection



Anti-Bacterial
Germ-Free Protection



Long Lasting
Maintenance Free



Save
Water



Efficient Flushing
Mechanism



Eco
Friendly

DIAMOND

SINGLE FLUSH

Model : BFC-004

Capacity : 10 Ltrs

M.R.P. : ₹ 1220/-

Available Colour :



ROYAL

DUAL FLUSH

Model : BFC-005

Capacity : 10 Ltrs

M.R.P. : ₹ 1690/-

Available Colour :



Push Button



with Easy
4 Ltr. & 8 Ltr.
Dual Flush



With
Air Freshener
Holder



**CISTERN INTERNAL
MECHANISMS**



Model : BFCA-001
M.R.P. : ₹ 752/-



ANMOL HANDLE
Model : BFCA-002
M.R.P. : ₹ 180/-



SINGLE FLUSH BALL COCK
Model : BFCA-003
M.R.P. : ₹ 165/-



SHORT BEND
Model : BFCA-007
M.R.P. : ₹ 76/-



MULTIPURPOSE
Model : BFCA-004
M.R.P. : ₹ 165/-



SINGLE FLUSH SYPHON
Model : BFCA-005
M.R.P. : ₹ 302/-



INLET VALVE 10LTRS
Model : BFCA-006
M.R.P. : ₹ 176/-



SINGLE LONG BEND
Model : BFCA-008
M.R.P. : ₹ 165/-



BALL COCK BALL WITH BRASS NUT
Model : BFCA-009 (15 mm) • M.R.P. : ₹ 95/-
Model : BFCA-010 (20 mm) • M.R.P. : ₹ 118/-
Model : BFCA-011 (25 mm) • M.R.P. : ₹ 144/-



ADOPTER
Model : BFCA-012
M.R.P. : ₹ 50/-



THREE PC LONG BEND
Model : BFCA-013
M.R.P. : ₹ 200/-

TOILET SEAT COVERS



Anti-Bacterial
Germ-Free Protection



Long Lasting
Maintenance Free



Save
Water



Efficient Flushing
Mechanism



Eco
Friendly

SOFT CLOSE

Suitable For Cascade & Wall Hung Sanitaryware

**SOFT
CLOSE** 

DIAMOND

Model : BSCA-001

M.R.P. : ₹ 1150/-



**SOFT
CLOSE** 

ANSHUL

Model : BSCA-002

M.R.P. : ₹ 1200/-



TOILET SEAT COVERS



Anti-Bacterial
Germ-Free Protection



Long Lasting
Maintenance Free



Save
Water



Efficient Flushing
Mechanism



Eco
Friendly

SOFT CLOSE

Suitable For Cascade & Wall Hung Sanitaryware

**SOFT
CLOSE** 

DOLPHIN

Model : BSCA-03

M.R.P. : ₹ 1220/-



**SOFT
CLOSE** 

ANMOL

Model : BSCA-004

M.R.P. : ₹ 1270/-



TOILET SEAT COVERS



Anti-Bacterial
Germ-Free Protection



Long Lasting
Maintenance Free



Save
Water



Efficient Flushing
Mechanism



Eco
Friendly

LOTUS

Model : BSCA-005

M.R.P. : ₹ 450/-

Available Colour :



HEXA

Model : BSCA-006

M.R.P. : ₹ 690/-

Available Colour :



TOILET SEAT COVERS



Anti-Bacterial
Germ-Free Protection



Long Lasting
Maintenance Free



Save
Water



Efficient Flushing
Mechanism



Eco
Friendly

ELEPHANT

Model : BSCA-007

M.R.P. : ₹ 650/-

Available Colour :



CURVE

Model : BSCA-008

M.R.P. : ₹ 680/-

Available Colour :



TOILET SEAT COVERS



Anti-Bacterial
Germ-Free Protection



Long Lasting
Maintenance Free



Save
Water



Efficient Flushing
Mechanism



Eco
Friendly

ANGLO RUBY

Model : BSCA-009

M.R.P. : ₹ 720/-

Available Colour :



ACCESSORIES



CURVE HINGES

Model : BSCAC-001

M.R.P. : ₹ 124/-



ELEPHANT EWC HINGES

Model : BSCAC-002

M.R.P. : ₹ 90/-



JET HINGES

Model : BSCAC-003

M.R.P. : ₹ 124/-



LOTUS EWC HINGES

Model : BSCAC-004

M.R.P. : ₹ 90/-



SYPHON WASHER

Model : BSCAC-005

M.R.P. : ₹ 34/-

DIAMOND 304 ISI SERIES

Collection



NON-MAGNETIC



HEAVY



RUST FREE



SS AISI-304 (18/8)



ISI-13983



SINGLE BOWL SINK

MODEL CODE	OVERALL SIZE	BOWL SIZE	PREMIUM
	in inches	in inches	
BSSDS 1215	12 x 15 x 5	10 x 13	4110/-
BSSDS 1416	14 x 16 x 6	12 x 14	4510/-
BSSDS 1618	16 x 18 x 8	14 x 16	4890/-
BSSDS 1818	18 x 18 x 7½	14 x 16	7400/-
BSSDS 1720	17 x 20 x 8	15 x 18	7800/-
BSSDS 1821	18 x 21 x 8	15 x 18	8200/-
BSSDS 1822	18 x 22 x 8	16 x 20	8400/-
BSSDS 1822A	18 x 22 x 8	16 x 20	8600/-
BSSDS 1824	18 x 22 x 9	16 x 20	9000/-
BSSDS 1824	18 x 24 x 8	16 x 22	9100/-
BSSDS 1824	18 x 24 x 9	16 x 20	9300/-
BSSDS 2024	20 x 24 x 8	16 x 22	9610/-

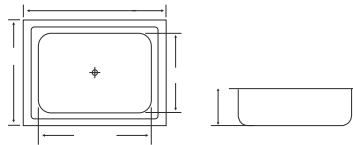

SINGLE BOWL TUB SINK

MODEL CODE	OVERALL SIZE	BOWL SIZE	PREMIUM
	in inches	in inches	
BSSDS 2127A	21 x 27 x 8	24 x 18	17100/-
BSSDS 2127B	21 x 27 x 9	24 x 18	18750/-

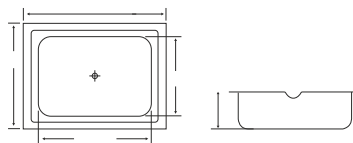

Features : Super Mirror Finish • 304 Grade

DIAMOND 304 ISI SERIES

Collection



NON-MAGNETIC



HEAVY



RUST FREE



AISI-304 (18/8)



IS:13983



SINGLE SINK WITH DRAIN BOARD

MODEL CODE	OVERALL SIZE	BOWL SIZE	PREMIUM
	in inches	in inches	
BSDSD 1832	18 x 32 x 8	14 x 16	13310/-
BSDSD 1836	18 x 36 x 8	14 x 16	13900/-
BSDSD 1837	18 x 37 x 8	16 x 20	14200/-
BSDSD 2045	20 x 45 x 8	16 x 20	17405/-
BSDSD 2041	20 x 41 x 8	16 x 20	17900/-
BSDSD 2040	20 x 40 x 8	16 x 20	18500/-
BSDSD 2042	20 x 42 x 8	16 x 20	19600/-

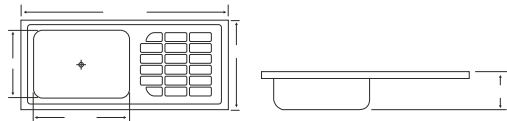

DOUBLE BOWL SINK

MODEL CODE	OVERALL SIZE	BOWL SIZE	PREMIUM
	in inches	in inches	
BSDDB 1837	18 x 37 x 9	14 x 16	18430/-
BSDDB 2045	20 x 45 x 8	16 x 20	19100/-
BSDDB 2045	20 x 45 x 9	16 x 20	19900/-
BSDDB 2045	20 x 45 x 10	16 x 20	20450/-



Features : Super Mirror Finish • 304 Grade

DOLPHINE 204 SQUARE ISI SERIES

Collection



NON-MAGNETIC



HEAVY



RUST FREE



SS
AISI-304 (18/8)



ISI-13983



SINGLE BOWL SINK

MODEL CODE	OVERALL SIZE	BOWL SIZE	PREMIUM
	in inches	in inches	
BSSDSB 1618	16 x 18 x 8	14 x 16	4500/-
BSSDSB 1824	18 x 24 x 9	16 x 20	5500/-

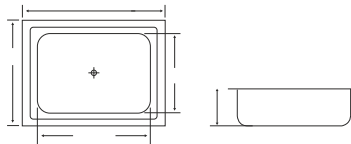

Features : Super Mirror Finish • 204CU Grade

ANSHUL 204 ISI SQUARE SERIES

Collection



NON-MAGNETIC



HEAVY



RUST FREE



AISI-304 (18/8)



IS:13983



SINGLE BOWL SINK

MODEL CODE	OVERALL SIZE	BOWL SIZE	PREMIUM
	in inches	in inches	
BSSASB 1215	12 x 15 x 5	10 x 13	3410/-
BSSASB 1416	14 x 16 x 6	12 x 14	3700/-
BSSASB 1618	16 x 18 x 8	14 x 16	3900/-
BSSASB 1818	18 x 18 x 7½	14 x 16	4200/-
BSSASB 1720	17 x 20 x 8	15 x 18	4310/-
BSSASB 1821	18 x 21 x 8	15 x 18	4420/-
BSSASB 1822	18 x 22 x 8	16 x 20	4480/-
BSSASB 1822A	18 x 22 x 8	16 x 20	4510/-
BSSASB 1824	18 x 22 x 9	16 x 20	4590/-
BSSASB 1824	18 x 24 x 8	16 x 22	4610/-
BSSASB 1824	18 x 24 x 9	16 x 20	4820/-
BSSASB 2024	20 x 24 x 8	16 x 22	5420/-
BSSASB 2424	24 x 24 x 9	22 x 22	7120/-

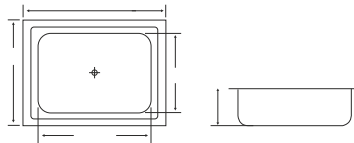

SINGLE BOWL TUB SINK

MODEL CODE	OVERALL SIZE	BOWL SIZE	PREMIUM
	in inches	in inches	
BSSASB 2127	21 x 27 x 8	24 x 18	5600/-
BSSASB 2127	21 x 27 x 9	24 x 18	5700/-

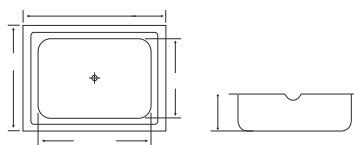

Features : Super Mirror Finish • 204CU Grade

ANSHUL 204 ISI SQUARE SERIES

Collection



NON-MAGNETIC



HEAVY



RUST FREE



SS AISI-304 (18/8)



IS-13983



SINGLE SINK WITH DRAIN BOARD

MODEL CODE	OVERALL SIZE	BOWL SIZE	PREMIUM
	in inches	in inches	
BSASS 1832	18 x 32 x 8	14 x 16	6100/-
BSASS 1836	18 x 36 x 8	14 x 16	6300/-
BSASS 1837	18 x 37 x 8	16 x 20	6600/-
BSASS 2045	20 x 45 x 8	16 x 20	7800/-
BSASS 2041	20 x 41 x 8	16 x 20	8400/-
BSASS 2040	20 x 40 x 8	16 x 20	8900/-
BSASS 2042	20 x 42 x 8	16 x 20	9100/-



DOUBLE SINK

MODEL CODE	OVERALL SIZE	BOWL SIZE	PREMIUM
	in inches	in inches	
BSADS 1837	18 x 37 x 8	14 x 16	10400/-
BSADS 2045 A	20 x 45 x 8	16 x 20	11500/-
BSADS 2045 B	20 x 45 x 9	16 x 20	12000/-
BSADS 2045 C	20 x 45 x 10	16 x 20	13400/-



Features : Super Mirror Finish • 204CU Grade

ROYAL 204 ISI SQUARE SERIES

Collection



NON-MAGNETIC



HEAVY



RUST FREE



AISI-304 (18/8)



IS:13983



SINGLE BOWL SINK

MODEL CODE	OVERALL SIZE	BOWL SIZE	PREMIUM
	in inches	in inches	
BSRSB 1215	12 x 15 x 5	10 x 13	1920/-
BSRSB 1416	14 x 16 x 6	12 x 14	2000/-
BSRSB 1618	16 x 18 x 8	14 x 16	3400/-
BSRSB 1818	18 x 18 x 7½	14 x 16	3700/-
BSRSB 1720	17 x 20 x 8	15 x 18	3960/-
BSRSB 1821	18 x 21 x 8	15 x 18	3980/-
BSRSB 1822	18 x 22 x 8	16 x 20	4050/-
BSRSB 1822A	18 x 22 x 8	16 x 20	4120/-
BSRSB 1824	18 x 22 x 9	16 x 20	4260/-
BSRSB 1824	18 x 24 x 8	16 x 22	4310/-
BSRSB 1824	18 x 24 x 9	16 x 20	4420/-
BSRSB 2024	20 x 24 x 8	16 x 22	6120/-
BSRSB 2424	24 x 24 x 9	22 x 22	7000/-

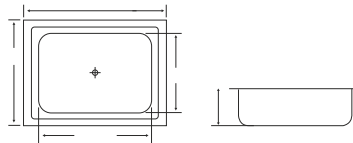

SINGLE BOWL TUB SINK

MODEL CODE	OVERALL SIZE	BOWL SIZE	PREMIUM
	in inches	in inches	
BSRSB 2127A	21 x 27 x 8	24 x 18	5600/-
BSRSB 2127B	21 x 27 x 9	24 x 18	6400/-

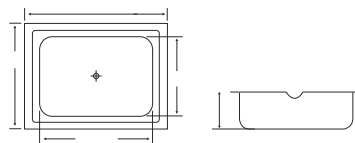

Features : Super Mirror Finish • 204CU Grade

ROYAL 204 ISI SQUARE SERIES

Collection



NON-MAGNETIC



HEAVY



RUST FREE



SS AISI-304 (18/8)



ISI-13983



SINGLE SINK WITH DRAIN BOARD

MODEL CODE	OVERALL SIZE	BOWL SIZE	PREMIUM
	in inches	in inches	
BSRSSD 1832	18 x 32 x 8	14 x 16	5050/-
BSRSSD 1836	18 x 36 x 8	14 x 16	5130/-
BSRSSD 1837	18 x 37 x 8	16 x 20	5210/-
BSRSSD 2045	20 x 45 x 8	16 x 20	6610/-
BSRSSD 2041	20 x 41 x 8	16 x 20	6820/-
BSRSSD 2040	20 x 40 x 8	16 x 20	7050/-
BSRSSD 2042	20 x 42 x 8	16 x 20	7250/-

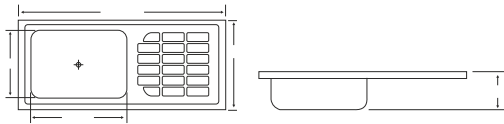

DOUBLE SINK

MODEL CODE	OVERALL SIZE	BOWL SIZE	PREMIUM
	in inches	in inches	
BSRDS 1837	18 x 37 x 9	14 x 16	7450/-
BSRDS 2045	20 x 45 x 8	16 x 20	9060/-
BSRDS 2045	20 x 45 x 9	16 x 20	9120/-
BSRDS 2045	20 x 45 x 10	16 x 20	9350/-

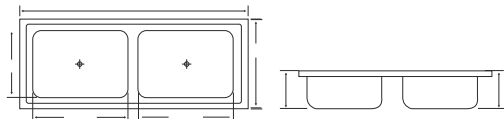

Features : Super Mirror Finish • 204CU Grade

ROYAL 204 ISI SQUARE SERIES

Collection



NON-MAGNETIC



HEAVY



RUST FREE



AISI-304 (18/8)



IS:13983



DOUBLE SINK WITH DRAIN BOARD

MODEL CODE	OVERALL SIZE	BOWL SIZE	PREMIUM
	in inches	in inches	
BSRDSD 1854	18 x 54 x 8	14 x 16	16020/-
BSRDSD 2068	20 x 68 x 8	16 x 20	19800/-

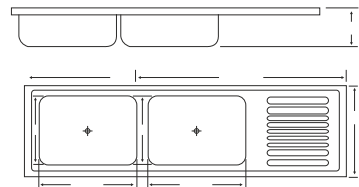

Features : Super Mirror Finish • 204CU Grade

ANMOL 202 SERIES

Collection



NON-MAGNETIC



HEAVY



RUST FREE



SS AISI-304 (18/8)



SINGLE BOWL SINK

MODEL CODE	OVERALL SIZE	BOWL SIZE	PREMIUM
	in inches	in inches	
BSASB 1215	12 x 15 x 5	10 x 13	1530/-
BSASB 1416	14 x 16 x 6	12 x 14	1770/-
BSASB 1618	16 x 18 x 8	14 x 16	2080/-
BSASB 1818	18 x 18 x 7½	14 x 16	2200/-
BSASB 1720	17 x 20 x 8	15 x 18	2250/-
BSASB 1821	18 x 21 x 8	15 x 18	2350/-
BSASB 1822	18 x 22 x 8	16 x 20	2400/-
BSASB 1822A	18 x 22 x 8	16 x 20	2450/-
BSASB 1824	18 x 22 x 9	16 x 20	2500/-
BSASB 1824	18 x 24 x 8	16 x 22	2650/-
BSASB 1824	18 x 24 x 9	16 x 20	2720/-
BSASB 2024	20 x 24 x 8	16 x 22	2990/-
BSASB 2424	24 x 24 x 9	22 x 22	5620/-

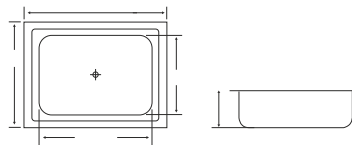

SINGLE BOWL TUB SINK

MODEL CODE	OVERALL SIZE	BOWL SIZE	PREMIUM
	in inches	in inches	
BSASB 2127A	21 x 27 x 8	24 x 18	5250/-
BSASB 2127B	21 x 27 x 9	24 x 18	5420/-

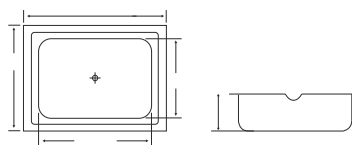

Features : Normal Finish • 202 Grade

ANMOL 202 SERIES

Collection



NON-MAGNETIC



HEAVY



RUST FREE



SS AISI-304 (18/8)



SINGLE SINK WITH DRAIN BOARD

MODEL CODE	OVERALL SIZE	BOWL SIZE	PREMIUM
	in inches	in inches	
BSASSD 1832	18 x 32 x 8	14 x 16	3620/-
BSASSD 1836	18 x 36 x 8	14 x 16	3710/-
BSASSD 1837	18 x 37 x 8	16 x 20	3800/-
BSASSD 2045	20 x 45 x 8	16 x 20	5900/-
BSASSD 2041	20 x 41 x 8	16 x 20	6100/-
BSASSD 2040	20 x 40 x 8	16 x 20	6300/-
BSASSD 2042	20 x 42 x 8	16 x 20	6500/-

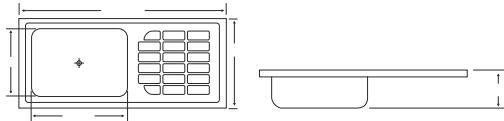

DOUBLE BOWL SINK

MODEL CODE	OVERALL SIZE	BOWL SIZE	PREMIUM
	in inches	in inches	
BSADBS 1837	18 x 37 x 9	14 x 16	4520/-
BSADBS 2045 A	20 x 45 x 8	16 x 20	6080/-
BSADBS 2045 B	20 x 45 x 8	16 x 20	6890/-
BSADBS 2045 C	20 x 45 x 10	16 x 20	9020/-

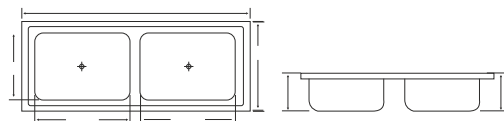

Features : Normal Finish • 202 Grade

PENDLE COLLECTION

A stylish and elegant design to give complete
bat space design



PDL-4101 MRP ₹ : 2050/-
Bib Cock



PDL-4102 MRP ₹ : 2170/-
Long Body



PDL-4103 MRP ₹ : 1530/-
Angle Cock



PDL-4104 MRP ₹ : 2180/-
Pillar Cock



PDL-4105 MRP ₹ : 2790/-
Two Way Bib Cock



PDL-4107 MRP ₹ : 2480/-
Sink Cock



PDL-4108 MRP ₹ : 2860/-
Swan Neck



PDL-4109 MRP ₹ : 5760/-
Sink Mixer



PDL-4110 MRP ₹ : 4446/-
Centre Hole Basin Mixer



PDL-4112 MRP ₹ : 2310/-
Flush Valve



PDL-4113 MRP ₹ : 1690/-
Concealed Valve



PDL-4114 MRP ₹ : 9432/-
2 in 1 wall mixer



PDL-4115 MRP ₹ : 9850/-
3 in 1 wall mixer



PDL-4117 MRP ₹ : 1050/-
Bath Spout with Wall Flange



PDL-4118 MRP ₹ : 1540/-
Bath Spout tipton with
Wall Flange



PDL-4119 MRP ₹ : 1690/-
Diverter

SMART COLLECTION

The mark of unique design that shaped modern
bath space



SMC-4202 — MRP ₹ : 2196/-
Long Body



SMC-4203 — MRP ₹ : 1800/-
Angle Cock



SMC-4204 — MRP ₹ : 2988/-
Pillar Cock



SMC-4205 — MRP ₹ : 3186/-
Two Way Bib Cock



SMC-4207 — MRP ₹ : 4716/-
Sink Cock



SMC-4208 — MRP ₹ : 4665/-
Swan Neck



SMC-4209 — MRP ₹ : 7488/-
Sink Mixer



SMC-4210 — MRP ₹ : 6912/-
Centre Hole Basin Mixer



SMC-4212 — MRP ₹ : 2538/-
Flush Valve



SMC-4213 — MRP ₹ : 1650/-
Concealed Valve



SMC-4214 — MRP ₹ : 9250/-
2 in 1 wall mixer



SMC-4215 — MRP ₹ : 9880/-
3 in 1 wall mixer

TRUMP COLLECTION

Minimalist design and seamless crafts for beautify
your bath surafce



TPC-4302 — MRP ₹ : 2130/-
Long Body



TPC-4303 — MRP ₹ : 1570/-
Angle Cock



TPC-4304 — MRP ₹ : 2450/-
Pillar Cock



TPC-4305 — MRP ₹ : 2730/-
Two Way Bib Cock



TPC-4307 — MRP ₹ : 2610/-
Sink Cock



TPC-4308 — MRP ₹ : 2910/-
Swan Neck



TPC-4309 — MRP ₹ : 5760/-
Sink Mixer



TPC-4310 — MRP ₹ : 4446/-
Centre Hole Basin Mixer



TPC-4312 — MRP ₹ : 2350/-
Flush Valve



TPC-4313 — MRP ₹ : 1650/-
Concealed Valve



TPC-4314 — MRP ₹ : 9432/-
2 in 1 wall mixer



TPC-4315 — MRP ₹ : 9750/-
3 in 1 wall mixer

MODERN COLLECTION

A classic and trendy looks design that convert bath space into aesthetic



MNC-4402 — MRP ₹ : 2466/-
Long Body



MNC-4403 — MRP ₹ : 1980/-
Angle Cock



MNC-4404 — MRP ₹ : 3384/-
Pillar Cock



MNC-4405 — MRP ₹ : 3348/-
Two Way Bib Cock



MNC-4407 — MRP ₹ : 4896/-
Sink Cock



MNC-4408 — MRP ₹ : 4860/-
Swan Neck



MNC-4409 — MRP ₹ : 8604/-
Sink Mixer



MNC-4410 — MRP ₹ : 7578/-
Centre Hole Basin Mixer



MNC-4412 — MRP ₹ : 2850/-
Flush Valve



MNC-4413 — MRP ₹ : 1710/-
Concealed Valve



MNC-4414 — MRP ₹ : 9590/-
2 in 1 wall mixer



MNC-4415 — MRP ₹ : 10494/-
3 in 1 wall mixer



MNC-4417 — MRP ₹ : 1950/-
Bath Spout with Wall Flange



MNC-4418 — MRP ₹ : 2420/-
Bath Spout tipton with
Wall Flange



MNC-4419 — MRP ₹ : 1960/-
Diverter

PORUS COLLECTION

Inspired by natural element that make perfect
bath space design



PSC-4502 — MRP ₹ : 2484/-
Long Body



PSC-4503 — MRP ₹ : 1800/-
Angle Cock



PSC-4504 — MRP ₹ : 2988/-
Pillar Cock



PSC-4505 — MRP ₹ : 3180/-
Two Way Bib Cock



PSC-4507 — MRP ₹ : 4710/-
Sink Cock



PSC-4508 — MRP ₹ : 4665/-
Swan Neck



PSC-4509 — MRP ₹ : 7486/-
Sink Mixer



PSC-4510 — MRP ₹ : 6912/-
Centre Hole Basin Mixer



PSC-4512 — MRP ₹ : 2538/-
Flush Valve



PSC-4513 — MRP ₹ : 1800/-
Concealed Valve



PSC-4514 — MRP ₹ : 9252/-
2 in 1 wall mixer



PSC-4515 — MRP ₹ : 9882/-
3 in 1 wall mixer



PSC-4517 — MRP ₹ : 1750/-
Bath Spout with Wall Flange



PSC-4518 — MRP ₹ : 1930/-
Bath Spout tipton with
Wall Flange



PSC-4519 — MRP ₹ : 2070/-
Diverter

ROMAN COLLECTION

A special crafting element to make a unique and personalized bath space.



RNC-3401 — MRP ₹ : 1245/-
Bib Cock



RNC-3402 — MRP ₹ : 1410/-
Long Body



RNC-3403 — MRP ₹ : 1110/-
Angle Cock



RNC-3404 — MRP ₹ : 1710/-
Pillar Cock



RNC-3405 — MRP ₹ : 2490/-
Two Way Bib Cock



RNC-3406 — MRP ₹ : 1890/-
Two Way Angle Cock



RNC-3407 — MRP ₹ : 3135/-
Sink Cock



RNC-3408 — MRP ₹ : 3450/-
Swan Neck



RNC-3409 MRP ₹ : 5400/-
Sink Mixer



RNC-3410 MRP ₹ : 6000/-
Centre Hole Basin Mixer



RNC-3412 MRP ₹ : 2385/-
Flush Valve



RNC-3413 MRP ₹ : 1425/-
Concealed Valve



RNC-3414 MRP ₹ : 6675/-
2 in 1 wall mixer



RNC-3415 MRP ₹ : 7275/-
3 in 1 wall mixer



RNC-3417 MRP ₹ : 1335/-
Bath Spout with Wall Flange



RNC-3418 MRP ₹ : 1785/-
Bath Spout tipton with
Wall Flange



RNC-3419 MRP ₹ : 1935/-
Diverter

TUCO COLLECTION

Create gorgeous setup that makes everything
attractive at bath space



TOC-1501 — MRP ₹ : 1360/-
Bib Cock



TOC-1502 — MRP ₹ : 1490/-
Long Body



TOC-1503 — MRP ₹ : 1020/-
Angle Cock



TOC-1504 — MRP ₹ : 1680/-
Pillar Cock



TOC-1505 — MRP ₹ : 1900/-
Two Way Bib Cock



TOC-1506 — MRP ₹ : 1930/-
Two Way Angle Cock



TOC-1507 — MRP ₹ : 2140/-
Sink Cock



TOC-1508 — MRP ₹ : 2360/-
Swan Neck



TOC-1509 — MRP ₹ : 3670/-
Sink Mixer



TOC-1510 — MRP ₹ : 4170/-
Centre Hole Basin Mixer



TOC-1512 — MRP ₹ : 2280/-
Flush Valve



TOC-1513 — MRP ₹ : 1470/-
Concealed Valve



TOC-1514 — MRP ₹ : 6300/-
2 in 1 wall mixer



TOC-1515 — MRP ₹ : 6730/-
3 in 1 wall mixer

RAID COLLECTION

Make marvelous bath design with stunning and attractive elements



RDC-3601 MRP ₹ : 1650/-
Bib Cock



RDC-3602 MRP ₹ : 1710/-
Long Body



RDC-3603 MRP ₹ : 1150/-
Angle Cock



RDC-3604 MRP ₹ : 2320/-
Pillar Cock



RDC-3605 MRP ₹ : 2260/-
Two Way Bib Cock



RDC-3606 MRP ₹ : 2050/-
Two Way Angle Cock



RDC-3607 MRP ₹ : 3090/-
Sink Cock



RDC-3608 MRP ₹ : 3370/-
Swan Neck



RDC-3609 MRP ₹ : 4490/-
Sink Mixer



RDC-3610 MRP ₹ : 4930/-
Centre Hole Basin Mixer



RDC-3612 MRP ₹ : 2268/-
Flush Valve



RDC-3613 MRP ₹ : 1510/-
Concealed Valve



RDC-3614 MRP ₹ : 6980/-
2 in 1 wall mixer



RDC-3615 MRP ₹ : 7430/-
3 in 1 wall mixer



RDC-3617 MRP ₹ : 1930/-
Bath Spout with Wall Flange



RDC-3618 MRP ₹ : 2180/-
Bath Spout tipton with
Wall Flange



RDC-3619 MRP ₹ : 2050/-
Diverter

ANSHUL COLLECTION

A modern touch that is suited for every contemporary
bath space design



ALC-1201 — MRP ₹ : 1030/-
Bib Cock



ALC-1202 — MRP ₹ : 1280/-
Long Body



ALC-1203 — MRP ₹ : 880/-
Angle Cock



ALC-1204 — MRP ₹ : 1447/-
Pillar Cock



ALC-1205 — MRP ₹ : 1640/-
Two Way Bib Cock



ALC-1206 — MRP ₹ : 1658/-
Two Way Angle Cock



ALC-1207 — MRP ₹ : 1720/-
Sink Cock



ALC-1208 — MRP ₹ : 1930/-
Swan Neck



ALC-1209 — MRP ₹ : 3720/-
Sink Mixer



ALC-1210 — MRP ₹ : 3410/-
Centre Hole Basin Mixer



ALC-1212 — MRP ₹ : 1875/-
Flush Valve



ALC-1213 — MRP ₹ : 1215/-
Concealed Valve



ALC-1214 — MRP ₹ : 5140/-
2 in 1 wall mixer



ALC-1215 — MRP ₹ : 5834/-
3 in 1 wall mixer

SIGNATURE COLLECTION

A collection to enhance the beauty of bathroom space



SEC-1301 — MRP ₹ : 1000/-
Bib Cock



SEC-1302 — MRP ₹ : 1160/-
Long Body



SEC-1303 — MRP ₹ : 790/-
Angle Cock



SEC-1304 — MRP ₹ : 1360/-
Pillar Cock



SEC-1305 — MRP ₹ : 1500/-
Two Way Bib Cock



SEC-1306 MRP ₹ : 1550/-
Two Way Angle Cock



SEC-1307 MRP ₹ : 1760/-
Sink Cock



SEC-1308 MRP ₹ : 1950/-
Swan Neck



SEC-1309 MRP ₹ : 3130/-
Sink Mixer



SEC-1310 MRP ₹ : 3472/-
Centre Hole Basin Mixer



SEC-1312 MRP ₹ : 1890/-
Flush Valve



SEC-1313 MRP ₹ : 1178/-
Concealed Valve



SEC-1314 MRP ₹ : 5200/-
2 in 1 wall mixer



SEC-1315 MRP ₹ : 5700/-
3 in 1 wall mixer

ORIS COLLECTION

A collection with stylish touch design that
become center of attractive



OSC-3701 — MRP ₹ : 1580/-
Bib Cock



OSC-3702 — MRP ₹ : 1780/-
Long Body



OSC-3703 — MRP ₹ : 1050/-
Angle Cock



OSC-3704 — MRP ₹ : 2280/-
Pillar Cock



OSC-3705 — MRP ₹ : 2322/-
Two Way Bib Cock



OSC-3706 — MRP ₹ : 2150/-
Two Way Angle Cock



OSC-3707 — MRP ₹ : 2890/-
Sink Cock



OSC-3708 — MRP ₹ : 3150/-
Swan Neck



OSC-3709 MRP ₹ : 4450/-
Sink Mixer



OSC-3710 MRP ₹ : 4850/-
Centre Hole Basin Mixer



OSC-3712 MRP ₹ : 2300/-
Flush Valve



OSC-3713 MRP ₹ : 1540/-
Concealed Valve



OSC-3714 MRP ₹ : 5400/-
2 in 1 wall mixer



OSC-3715 MRP ₹ : 6120/-
3 in 1 wall mixer



OSC-3717 MRP ₹ : 1650/-
Bath Spout with Wall Flange



OSC-3718 MRP ₹ : 1950/-
Bath Spout tipton with
Wall Flange



OSC-3719 MRP ₹ : 2010/-
Diverter

ORIO COLLECTION

With exclusive design that perfectly suit at bath space



OOC-1401 — MRP ₹ : 1050/-
Bib Cock



OOC-1402 — MRP ₹ : 1130/-
Long Body



OOC-1403 — MRP ₹ : 820/-
Angle Cock



OOC-1404 — MRP ₹ : 1430/-
Pillar Cock



OOC-1405 — MRP ₹ : 1790/-
Two Way Bib Cock



OOC-1406 MRP ₹ : 1590/-
Two Way Angle Cock



OOC-1407 MRP ₹ : 1760/-
Sink Cock



OOC-1408 MRP ₹ : 2015/-
Swan Neck



OOC-1409 MRP ₹ : 3780/-
Sink Mixer



OOC-1410 MRP ₹ : 3470/-
Centre Hole Basin Mixer



OOC-1412 MRP ₹ : 1880/-
Flush Valve



OOC-1413 MRP ₹ : 1196/-
Concealed Valve



OOC-1414 MRP ₹ : 5480/-
2 in 1 wall mixer



OOC-1415 MRP ₹ : 5834/-
3 in 1 wall mixer

OZONE COLLECTION

An exclusive impression that offered by art and stylish design



ORG-3301 MRP ₹ : 860/-
Bib Cock



ORG-3302 MRP ₹ : 980/-
Long Body



ORG-3303 MRP ₹ : 710/-
Angle Cock



ORG-3304 MRP ₹ : 1170/-
Pillar Cock



ORG-3305 MRP ₹ : 1875/-
Two Way Bib Cock



ORG-3306 MRP ₹ : 1875/-
Two Way Angle Cock



ORG-3307 MRP ₹ : 2000/-
Sink Cock



ORG-3308 MRP ₹ : 2000/-
Swan Neck



ORG-3309 MRP ₹ : 3920/-
Sink Mixer



ORG-3310 MRP ₹ : 4170/-
Centre Hole Basin Mixer



ORG-3312 MRP ₹ : 2060/-
Flush Valve



ORG-3313 MRP ₹ : 1260/-
Concealed Valve



ORG-3314 MRP ₹ : 5300/-
2 in 1 wall mixer



ORG-3315 MRP ₹ : 5610/-
3 in 1 wall mixer



ORG-3317 MRP ₹ : 1210/-
Bath Spout with Wall Flange



ORG-3318 MRP ₹ : 1510/-
Bath Spout tipton with
Wall Flange



ORG-3319 MRP ₹ : 1820/-
Diverter

ANMOL
COLLECTION



ANC-1901 — MRP ₹ : 915/-
Bib Cock



ANC-1902 — MRP ₹ : 945/-
Long Body



ANC-1903 — MRP ₹ : 765/-
Angle Cock



ANC-1904 — MRP ₹ : 1180/-
Pillar Cock



ANC-1905 — MRP ₹ : 1730/-
Two Way Bib Cock



ANC-1906 — MRP ₹ : 1830/-
Two Way Angle Cock



ANC-1907 — MRP ₹ : 1890/-
Sink Cock



ANC-1908 — MRP ₹ : 2150/-
Swan Neck



ANC-1909 — MRP ₹ : 4110/-
Sink Mixer



ANC-1910 — MRP ₹ : 3670/-
Centre Hole Basin Mixer



ANC-1912 — MRP ₹ : 2150/-
Flush Valve



ANC-1913 — MRP ₹ : 1290/-
Concealed Valve



ANC-1914 — MRP ₹ : 5940/-
2 in 1 wall mixer



ANC-1915 — MRP ₹ : 6370/-
3 in 1 wall mixer

SCOTT
COLLECTION



STC-3201 — MRP ₹ : 800/-
Bib Cock



STC-3202 — MRP ₹ : 920/-
Long Body



STC-3203 — MRP ₹ : 720/-
Angle Cock



STC-3204 — MRP ₹ : 1040/-
Pillar Cock



STC-3205 — MRP ₹ : 1290/-
Two Way Bib Cock



STC-3206 MRP ₹ : 1860/-
Two Way Angle Cock



STC-3207 MRP ₹ : 1920/-
Sink Cock



STC-3208 MRP ₹ : 1920/-
Swan Neck



STC-3209 MRP ₹ : 3240/-
Sink Mixer



STC-3210 MRP ₹ : 3570/-
Centre Hole Basin Mixer



STC-3212 MRP ₹ : 1850/-
Flush Valve



STC-3213 MRP ₹ : 1190/-
Concealed Valve



STC-3214 MRP ₹ : 5230/-
2 in 1 wall mixer



STC-3215 MRP ₹ : 5460/-
3 in 1 wall mixer

CHOCOLATE
COLLECTION



CEC-1701 — MRP ₹ : 888/-
Bib Cock



CEC-1702 — MRP ₹ : 936/-
Long Body



CEC-1703 — MRP ₹ : 645/-
Angle Cock



CEC-1704 — MRP ₹ : 945/-
Pillar Cock



CEC-1705 — MRP ₹ : 1510/-
Two Way Bib Cock



CEC-1706 MRP ₹ : 1470/-
Two Way Angle Cock



CEC-1707 MRP ₹ : 1655/-
Sink Cock



CEC-1708 MRP ₹ : 1655/-
Swan Neck



CEC-1709 MRP ₹ : 3230/-
Sink Mixer



CEC-1710 MRP ₹ : 3426/-
Centre Hole Basin Mixer



CEC-1712 MRP ₹ : 1710/-
Flush Valve



CEC-1713 MRP ₹ : 1050/-
Concealed Valve



CEC-1714 MRP ₹ : 4900/-
2 in 1 wall mixer



CEC-1715 MRP ₹ : 5340/-
3 in 1 wall mixer

REAL
COLLECTION



RYL-3101 — MRP ₹ : 680/-
Bib Cock



RYL-3102 — MRP ₹ : 780/-
Long Body



RYL-3103 — MRP ₹ : 630/-
Angle Cock



RYL-3104 — MRP ₹ : 990/-
Pillar Cock



RYL-3105 — MRP ₹ : 1230/-
Two Way Bib Cock



RYL-3106 — MRP ₹ : 1725/-
Two Way Angle Cock



RYL-3107 — MRP ₹ : 1780/-
Sink Cock



RYL-3108 — MRP ₹ : 1780/-
Swan Neck



RYL-3109 — MRP ₹ : 3110/-
Sink Mixer



RYL-3110 — MRP ₹ : 3540/-
Centre Hole Basin Mixer



RYL-3112 — MRP ₹ : 1840/-
Flush Valve



RYL-3113 — MRP ₹ : 1125/-
Concealed Valve



RYL-3114 — MRP ₹ : 4250/-
2 in 1 wall mixer



RYL-3115 — MRP ₹ : 4720/-
3 in 1 wall mixer

LORET
COLLECTION



LTC-1801 MRP ₹ : 840/-
Bib Cock



LTC-1802 MRP ₹ : 960/-
Long Body



LTC-1803 MRP ₹ : 660/-
Angle Cock



LTC-1804 MRP ₹ : 1035/-
Pillar Cock



LTC-1805 MRP ₹ : 1410/-
Two Way Bib Cock



LTC-1806 — MRP ₹ : 1260/-
Two Way Angle Cock



LTC-1807 — MRP ₹ : 1960/-
Sink Cock



LTC-1808 — MRP ₹ : 1960/-
Swan Neck



LTC-1809 — MRP ₹ : 3810/-
Sink Mixer



LTC-1810 — MRP ₹ : 3440/-
Centre Hole Basin Mixer



LTC-1812 — MRP ₹ : 1890/-
Flush Valve



LTC-1813 — MRP ₹ : 1200/-
Concealed Valve



LTC-1814 — MRP ₹ : 5700/-
2 in 1 wall mixer



LTC-1815 — MRP ₹ : 5950/-
3 in 1 wall mixer

ALIVE
COLLECTION



AEC-1101 — MRP ₹ : 870/-
Bib Cock



AEC-1102 — MRP ₹ : 900/-
Long Body



AEC-1103 — MRP ₹ : 720/-
Angle Cock



AEC-1104 — MRP ₹ : 1140/-
Pillar Cock



AEC-1105 — MRP ₹ : 1455/-
Two Way Bib Cock



AEC-1106 — MRP ₹ : 1560/-
Two Way Angle Cock



AEC-1107 — MRP ₹ : 1560/-
Sink Cock



AEC-1108 — MRP ₹ : 1815/-
Swan Neck



AEC-1109 — MRP ₹ : 3495/-
Sink Mixer



AEC-1110 — MRP ₹ : 3150/-
Centre Hole Basin Mixer



AEC-1112 — MRP ₹ : 1605/-
Flush Valve



AEC-1113 — MRP ₹ : 1110/-
Concealed Valve



AEC-1114 — MRP ₹ : 4920/-
2 in 1 wall mixer



AEC-1115 — MRP ₹ : 5400/-
3 in 1 wall mixer

PERFECT
COLLECTION



PRE-1501 — MRP ₹ : 780/-
Bib Cock



PRE-1502 — MRP ₹ : 875/-
Long Body



PRE-1503 — MRP ₹ : 650/-
Angle Cock



PRE-1504 — MRP ₹ : 1030/-
Pillar Cock



PRE-1505 — MRP ₹ : 1340/-
Two Way Bib Cock



PRE-1506 MRP ₹ : 1440/-
Two Way Angle Cock



PRE-1507 MRP ₹ : 1790/-
Sink Cock



PRE-1508 MRP ₹ : 1790/-
Swan Neck



PRE-1509 MRP ₹ : 3110/-
Sink Mixer



PRE-1510 MRP ₹ : 3540/-
Centre Hole Basin Mixer



PRE-1512 MRP ₹ : 1890/-
Flush Valve



PRE-1513 MRP ₹ : 1090/-
Concealed Valve



PRE-1514 MRP ₹ : 4560/-
2 in 1 wall mixer



PRE-1515 MRP ₹ : 5088/-
3 in 1 wall mixer



FIS-1601 — MRP ₹ : 830/-
Bib Cock



FIS-1602 — MRP ₹ : 890/-
Long Body



FIS-1603 — MRP ₹ : 690/-
Angle Cock



FIS-1604 — MRP ₹ : 960/-
Pillar Cock



FIS-1605 — MRP ₹ : 1725/-
Two Way Bib Cock



FIS-1606 MRP ₹ : 1725/-
Two Way Angle Cock



FIS-1607 MRP ₹ : 1800/-
Sink Cock



FIS-1608 MRP ₹ : 1800/-
Swan Neck



FIS-1609 MRP ₹ : 3525/-
Sink Mixer



FIS-1610 MRP ₹ : 3915/-
Centre Hole Basin Mixer



FIS-1612 MRP ₹ : 2030/-
Flush Valve



FIS-1613 MRP ₹ : 1250/-
Concealed Valve



FIS-1614 MRP ₹ : 4910/-
2 in 1 wall mixer



FIS-1615 MRP ₹ : 5560/-
3 in 1 wall mixer

MEDICAL
COLLECTION



MED-501 ————— MRP ₹ : 2800/-
Medical Long Body



MED-502 ————— MRP ₹ : 2840/-
Medical Pillar Cock



MED-511 ————— MRP ₹ : 3960/-
Sink Cock



MED-512 ————— MRP ₹ : 4220/-
Swan Neck

SINGLE LEVER SINK MIXTURE COLLECTION



SIN-503 _____ MRP ₹ : 8652/-
Orange Single Lever Sink Mixture



SIN-504 _____ MRP ₹ : 8890/-
Roman Single Lever Sink Mixture



SIN-505 _____ MRP ₹ : 9030/-
Raid Single Lever Sink Mixture



SIN-506 _____ MRP ₹ : 8988/-
Oris Single Lever Sink Mixture



SIN-507 _____ MRP ₹ : 9500/-
Porus Single Lever Sink Mixture



SIN-508 _____ MRP ₹ : 9180/-
Pendle Single Lever Sink Mixture



SIN-509 _____ MRP ₹ : 9450/-
Modern Single Lever Sink Mixture



DNA-3420 _____ MRP ₹ : 5180/-
Single Lever Concealed Diverter
Body (40mm cartridge + Tipton)



DNA-3421 _____ MRP ₹ : 5880/-
High Flow Single Lever Concealed
Diverter Body (45mm cartridge
+ Tipton)

MOUTH OPERATED COLLECTION



MOU-522 — MRP ₹ : 1890/-
Bib Cock



MOU-520 — MRP ₹ : 2100/-
Long Body



MOU-524 — MRP ₹ : 4200/-
High Neck Pillar Cock



MOU-523 — MRP ₹ : 2535/-
Long Body



MOU-521 — MRP ₹ : 2835/-
Pillar Cock

PUSH OPERATOR
COLLECTION



PUS-525 MRP ₹ : 7185/-
Metropole Flush Valve 25 MM



PUS-526 MRP ₹ : 7245/-
Metropole Flush Valve 40 MM



PUS-527 MRP ₹ : 7485/-
Metropole Flush Valve 25 MM



PUS-528 MRP ₹ : 7545/-
Metropole Flush Valve 40 MM



PUS-529 MRP ₹ : 4335/-
Push Pillar Cock



PUS-530 MRP ₹ : 3975/-
Push Bib Cock With Wall Flange



PUS-531 MRP ₹ : 3825/-
Urinal Flusher With Wall Flange

HIGH NECK COLLECTION



HN-534 — MRP ₹ : 4215/-
Anshul



HN-535 — MRP ₹ : 4275/-
Signature



HN-536 — MRP ₹ : 4335/-
Orio



HN-537 — MRP ₹ : 4140/-
Orange



HN-538 — MRP ₹ : 4305/-
Anmol



HN-539 — MRP ₹ : 4185/-
Scott



HN-540 — MRP ₹ : 4215/-
Chocolate



HN-541 — MRP ₹ : 4185/-
Royal



HN-542 — MRP ₹ : 4275/-
Loret



HN-544 — MRP ₹ : 4200/-
ALIVE



HN-545 — MRP ₹ : 4140/-
Prince



HN-546 — MRP ₹ : 4155/-
Fish

SINGLE LEVER HIGH NECK COLLECTION



SLH-531 _____ MRP ₹ : 14925/-
Single Lever High Neck - 1



SLH-532 _____ MRP ₹ : 17685/-
Single Lever High Neck - 2



SLH-533 _____ MRP ₹ : 18375/-
Single Lever High Neck - 3

ACCESSORIES COLLECTION



Mixer Tik-Tik cartridge

AC801	25mm	MRP ₹ : 330/-
AC802	30mm	MRP ₹ : 352/-



Diverter Cartridge

AC803	40mm	MRP ₹ : 492/-
AC804	45mm	MRP ₹ : 705/-



Diverter cartridge Tik-Tik

AC805	30mm	MRP ₹ : 625/-
-------	------	---------------



Brass Spindle 15 mm

AC806	MRP ₹ : 145/-
-------	---------------



Brass Spindle 20 mm

AC807	MRP ₹ : 290/-
-------	---------------



Conslied Spindle, Flush Spindle

AC808	Conslied Spindle 15 mm	MRP ₹ : 300/-
-------	------------------------	---------------

AC809	Flush Spindle 25 mm	MRP ₹ : 385/-
-------	---------------------	---------------



Single Lever Cartridge

AC810	MRP ₹ : 352.50/-
-------	------------------



AC901
Foam Flow

MRP ₹ : 90/-



AC904
Mixer L Band

MRP ₹ : 570/-



AC905
Mixer V Cape

MRP ₹ : 66/-



AC906
Shower Arm Round

6"	MRP ₹ : 202/-
9"	MRP ₹ : 277/-



AC907
Shower Arm Square

9"	MRP ₹ : 480/-
12"	MRP ₹ : 555/-
18"	MRP ₹ : 675/-

Bottle Trap



BAL-1001
Bottle Trap
₹ 1190/-

Extension Nipples Brass



BAL-1017	BAL-1016	BAL-1015	BAL-1014	BAL-1013	BAL-1012	BAL-1011
6"	4"	3"	2 1/2"	2"	1 1/2"	1"
₹ 391/-	₹ 271/-	₹ 196/-	₹ 164/-	₹ 126/-	₹ 111/-	₹ 74/-

Extension Nipple Brass

Hex Nipple



BAL-1021
CP Hex Nipple
₹ 105/-

Extension Nipples SS



BAL-1034	BAL-1033	BAL-1032	BAL-1031
2 1/2"	2"	1 1/2"	1"
₹ 90/-	₹ 80/-	₹ 60/-	₹ 48/-

Regular Waste Couplings



BAL-1041
Deluxe Waste Coupling
₹ 140/-



BAL-1042
Dolphin Waste Coupling
₹ 170/-



BAL-1043
Anmol Brass CP
Waste Coupling
₹ 290/-



JET SPRAYS



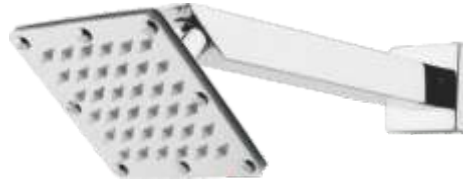

ONLY HEAD (4" x 4") BSVSD-0404 ₹ 975/-	ONLY HEAD (6" x 6") BSVSD-0606 ₹ 1406/-	ONLY HEAD (8" x 8") BSVSD-0808 ₹ 1840/-	ONLY HEAD (12" x 12") BSVSD-1212 ₹ 4115/-
WITH ARM (S.S 9" SQ.) BSVSD-A44 ₹ 1280/-	WITH ARM (S.S 12" SQ.) BSVSD-A66 ₹ 1802/-	WITH ARM (S.S 15" SQ.) BSVSD-A88 ₹ 2302/-	WITH ARM (S.S 21" SQ.) BSVSD-A1212 ₹ 4634/-

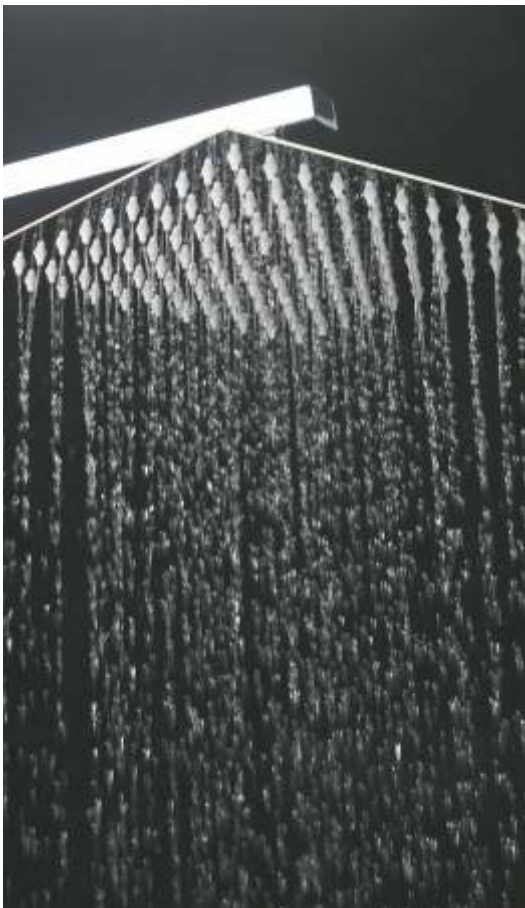

S.S. ULTRA SLIM SHOWER

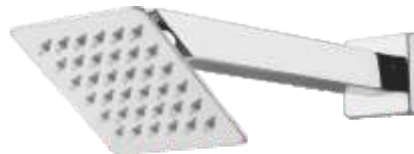

ONLY HEAD (4" x 4") BSVUS-0404 ₹ 630/-	ONLY HEAD (6" x 6") BSVUS-0606 ₹ 820/-	ONLY HEAD (8" x 8") BSVUS-0808 ₹ 1092/-
WITH ARM (S.S 9" SQ.) BSVUS-A44 ₹ 1001/-	WITH ARM (S.S 12" SQ.) BSVUS-A66 ₹ 1323/-	WITH ARM (S.S 15" SQ.) BSVUS-A88 ₹ 1791/-

A-MAZE SHOWER

S.S 304 CHROME PLATED



Here every part
of your body

will get **WET...**

4" x 4"
BSVMZ-0404
₹ 1557/-

6" x 6"
BSVMZ-0606
₹ 2200/-

8" x 8"
BSVMZ-0808
₹ 2587/-

MAZZEY SHOWER

S.S 202 MIRROR FINISHED

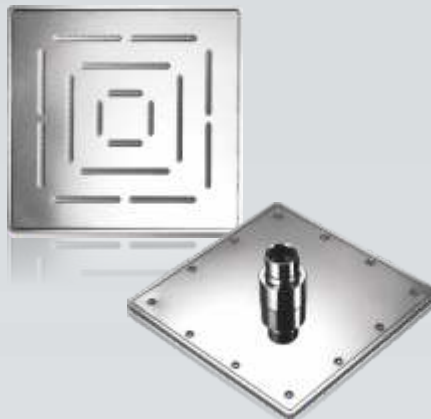

4" x 4"
BSVZZ-0404
₹ 670/-

6" x 6"
BSVZZ-0606
₹ 1080/-

8" x 8"
BSVZZ-0808
₹ 1430/-

SHOWER SYSTEM

ABS BEND SHOWERS



ARTIZ Light
BSVBS-0113
₹ 627/-



ARTIZ Hy.
BSVBS-0114
₹ 806/-

AXIS
BSVBS-0115
₹ 750/-



VENTO
BSVBS-0116
₹ 830/-



SUNFLOWER
BSVBS-0117
₹ 650/-



PRIME
BSVBS-0118
₹ 690/-



AURA
BSVBS-0119
₹ 642/-



KUBIX (100mm x 100mm)
BSVBS-0120
₹ 665/-



PLUTO
BSVBS-0121
₹ 660/-



LAVENDER
BSVBS-0122
₹ 624/-



NEW AQUA
BSVBS-0123
₹ 475/-



NICE (5" x 5")
BSVBS-0124
₹ 962/-



SUN
BSVBS-0101
₹ 800/-



MOON
BSVBS-0102
₹ 820/-



JUPITER
BSVBS-0104
₹ 750/-



NEPTUNE
BSVBS-0105
₹ 880/-



JAQUAR 5"
BSVBS-0106
₹ 830/-



MARIGOLD-H
(Multi Flow)
BSVBS-0107
₹ 886/-



MARIGOLD-M
(Multi Flow)
BSVBS-0108
₹ 1030/-



MARIGOLD CP
(Multi Flow)
BSVBS-0109
₹ 770/-



MARIGOLD
(Multi Flow)
BSVBS-0110
₹ 870/-



SILVER BELL
BSVBS-0111
₹ 806/-



VENUS
BSVBS-0112
₹ 980/-



MARC
BSVBS-0125
₹ 690/-



MARINA
BSVBS-0126
₹ 620/-



MARINA
BSVBS-0127
₹ 720/-



ALDO
BSVBS-0128
₹ 720/-



OCEAN
BSVBS-0129
₹ 890/-



BELL Light
BSVBS-0130
₹ 590/-

BELL Hy.
BSVBS-0131
₹ 800/-



LOREX
BSVBS-0132
₹ 695/-



AMAZE
BSVBS-0133
₹ 650/-



GALAXY
BSVBS-0134
₹ 690/-



NANO Light
BSVBS-0135
₹ 690/-

NANO Hy.
BSVBS-0136
₹ 750/-



LOTUS
BSVBS-0137
₹ 810/-



ESSCO
BSVBS-0151
₹ 650/-



SLIM 2" X 3"
BSVBS-0138
₹ 450/-

PENGUIN
BSVBS-0139
₹ 490/-



AROMA
BSVBS-0150
₹ 390/-

METRO
BSVBS-0141
₹ 370/-

SONA
BSVBS-0142
₹ 475/-

ORBIT
BSVBS-0143
₹ 390/-



MAZE (4" x 6")
BSVBS-0144
₹ 1196/- (with 12" Sq. Arm)
₹ 1080/- (with 9" Sq. Arm)
₹ 951/- (with 9" Rd.. Arm)



MAZE (Alive)
BSVBS-0145
₹ 1210/- (with 12" Sq. Arm)
₹ 1110/- (with 9" Sq. Arm)
₹ 980/- (with 9" Rd.. Arm)



MAZE (Ultra)
BSVBS-0146
₹ 1190/- (with 12" Sq. Arm)
₹ 1070/- (with 9" Sq. Arm)
₹ 940/- (with 9" Rd.. Arm)



MAZE (Slim)
BSVBS-0147
₹ 1150/- (with 12" Sq. Arm)
₹ 1040/- (with 9" Sq. Arm)
₹ 920/- (with 9" Rd.. Arm)



KUBIX (5" x 5")
BSVBS-0148
₹ 1196/- (with 12" Sq. Arm)
₹ 1080/- (with 9" Sq. Arm)
₹ 951/- (with 9" Rd.. Arm)



RECTA (Slim) 3"x5"
BSVBS-0149
₹ 884/- (with 12" Sq. Arm)
₹ 754/- (with 9" Sq. Arm)
₹ 598/- (with 9" Rd.. Arm)

TELEPHONIC SHOWER ABS



ROSS (Multi Flow)
BSVTS-0201
₹ 1950/- (S.S Tube & Hook)
₹ 2130/- (S.S Hy. Tube & Hook)



MISTY (Multi Flow)
BSVTS-0202
₹ 1713/- (S.S Tube & Hook)
₹ 1890/- (S.S Hy. Tube & Hook)



FLO MIST (Multi Flow)
BSVTS-0203
₹ 1713/- (S.S Tube & Hook)
₹ 1895/- (S.S Hy. Tube & Hook)



OMEGA
BSVTS-0204
₹ 1427/- (S.S Tube & Hook)
₹ 1610/- (S.S Hy. Tube & Hook)



SLIM
BSVTS-0205
₹ 1430/- (S.S Tube & Hook)
₹ 1610/- (S.S Hy. Tube & Hook)



DOLPHIN
BSVTS-0206
₹ 1450/- (S.S Tube & Hook)
₹ 1650/- (S.S Hy. Tube & Hook)



KUBIX
BSVTS-0207
₹ 1427/- (S.S Tube & Hook)
₹ 1610/- (S.S Hy. Tube & Hook)



SLEEK
BSVTS-0208
₹ 1248/- (S.S Tube & Hook)
₹ 1430/- (S.S Hy. Tube & Hook)



ATLANTIS
BSVTS-0209
₹ 1066/- (S.S Tube & Hook)
₹ 1118/- (S.S Hy. Tube & Hook)



LIVA
BSVTS-0210
₹ 1080/- (S.S Tube & Hook)
₹ 1250/- (S.S Hy. Tube & Hook)



TWINKLE
BSVTS-0211
₹ 884/- (S.S Tube & Hook)
₹ 1060/- (S.S Hy. Tube & Hook)



SPIKE
BSVTS-0212
₹ 900/- (S.S Tube & Hook)
₹ 1080/- (S.S Hy. Tube & Hook)



RECTA
BSVTS-0213
₹ 1100/- (S.S Tube & Hook)
₹ 1300/- (S.S Hy. Tube & Hook)



CAMEL
BSVTS-0214
₹ 800/- (S.S Tube & Hook)
₹ 980/- (S.S Hy. Tube & Hook)



POLO
BSVTS-0215
₹ 1300/- (S.S Tube & Hook)
₹ 1480/- (S.S Hy. Tube & Hook)



BREEZA
(Multi Flow)
BSVTS-0216
₹ 1375/- (S.S Tube & Hook)
₹ 1557/- (S.S Hy. Tube & Hook)



ASPIRE
(Multi Flow)
BSVTS-0217
₹ 1375/- (S.S Tube & Hook)
₹ 1557/- (S.S Hy. Tube & Hook)



VENUS
BSVTS-0218
₹ 1558/- (S.S Tube & Hook)
₹ 1757/- (S.S Hy. Tube & Hook)



JETTA
(Multi Flow)
BSVTS-0219
₹ 1375/- (S.S Tube & Hook)
₹ 1557/- (S.S Hy. Tube & Hook)



MARRIGOLD-R
(Multi Flow)
BSVTS-0220
₹ 1390/- (S.S Tube & Hook)
₹ 1650/- (S.S Hy. Tube & Hook)



APPLE
BSVTS-0221
₹ 1410/- (S.S Tube & Hook)
₹ 1710/- (S.S Hy. Tube & Hook)



JAQUAR
BSVTS-0222
₹ 1450/- (S.S Tube & Hook)
₹ 1720/- (S.S Hy. Tube & Hook)



SPARKLE
BSVTS-0223
₹ 1420/- (S.S Tube & Hook)
₹ 1700/- (S.S Hy. Tube & Hook)



CASA
BSVTS-0224
₹ 1460/- (S.S Tube & Hook)
₹ 1790/- (S.S Hy. Tube & Hook)



EVON
BSVTS-0225
₹ 1080/- (S.S Tube & Hook)
₹ 1250/- (S.S Hy. Tube & Hook)



OPAL
BSVTS-0225
₹ 1480/- (S.S Tube & Hook)
₹ 1810/- (S.S Hy. Tube & Hook)



OCEAN
BSVTS-0227
₹ 1150/- (S.S Tube & Hook)
₹ 1390/- (S.S Hy. Tube & Hook)



NANO
BSVTS-0228
₹ 1090/- (S.S Tube & Hook)
₹ 1260/- (S.S Hy. Tube & Hook)



BELL
BSVTS-0229
₹ 1185/- (S.S Tube & Hook)
₹ 1390/- (S.S Hy. Tube & Hook)



- ✓ Environmental BRASS Material
- ✓ Water Saving and Smooth Water Flow
- ✓ Thumb Control & Five Layers Plating

BRASS HEALTH FAUCETS



AUDI

BSVHF-5201
₹ 2150/- (S.S Tube & Hook)
₹ 2310/- (S.S Hy. Tube & Hook)



SLEEK

BSVHF-5202
₹ 1840/- (S.S Tube & Hook)
₹ 2000/- (S.S Hy. Tube & Hook)



AXIZ

BSVHF-5203
₹ 1600/- (S.S Tube & Hook)
₹ 2080/- (S.S Hy. Tube & Hook)



ARIA

BSVHF-5204
₹ 1820/- (S.S Tube & Hook)
₹ 1970/- (S.S Hy. Tube & Hook)



CUBIX

BSVHF-5205
₹ 1680/- (S.S Tube & Hook)
₹ 1840/- (S.S Hy. Tube & Hook)



SOLO

BSVHF-5206
₹ 1280/- (S.S Tube & Hook)
₹ 1440/- (S.S Hy. Tube & Hook)



COMPAQ

BSVHF-5207
₹ 1375/- (S.S Tube & Hook)
₹ 1530/- (S.S Hy. Tube & Hook)



JOY

BSVHF-5208
₹ 1092/- (S.S Tube & Hook)
₹ 1248/- (S.S Hy. Tube & Hook)



DOLPHIN

BSVHF-5209
₹ 1400/- (S.S Tube & Hook)
₹ 1557/- (S.S Hy. Tube & Hook)



NEW SOLO

BSVHF-5210
₹ 1260/- (S.S Tube & Hook)
₹ 1428/- (S.S Hy. Tube & Hook)



ROYAL

BSVHF-5211
₹ 1344/- (S.S Tube & Hook)
₹ 1512/- (S.S Hy. Tube & Hook)



CONCEPT

BSVHF-5212
₹ 1510/- (S.S Tube & Hook)
₹ 1670/- (S.S Hy. Tube & Hook)



SKINO

BSVHF-5213
₹ 1510/- (S.S Tube & Hook)
₹ 1680/- (S.S Hy. Tube & Hook)



AMBASSADOR

BSVHF-5214
₹ 1610/- (S.S Tube & Hook)
₹ 1780/- (S.S Hy. Tube & Hook)



MILANO

BSVHF-5215
₹ 1650/- (S.S Tube & Hook)
₹ 1810/- (S.S Hy. Tube & Hook)



MARINA

BSVHF-5216
₹ 1260/- (S.S Tube & Hook)
₹ 1420/- (S.S Hy. Tube & Hook)



NOZZET

BSVHF-5217
₹ 1344/- (S.S Tube & Hook)
₹ 1520/- (S.S Hy. Tube & Hook)



VISA

BSVHF-5218
₹ 2230/- (S.S Tube & Hook)
₹ 2405/- (S.S Hy. Tube & Hook)

ABS

HEALTH FAUCETS

- ✓ Environmental ABS Material ✓ Water Saving and Smooth Water Flow ✓ Thumb Control & Five Layers Plating



SUPERB

BSVHF-5219
₹ 1480/- (S.S Tube & Hook)
₹ 1650/- (S.S Heavy Stretchable)



ELENTRA

BSVHF-5220
₹ 1325/- (S.S Tube & Hook)
₹ 1490/- (S.S Heavy Stretchable)



PLUTO

BSVHF-5221
₹ 1670/- (S.S Tube & Hook)
₹ 1845/- (S.S Heavy Stretchable)



MILI

BSVHF-5222
₹ 1020/- (S.S Tube & Hook)
₹ 1190/- (S.S Heavy Stretchable)



NOVEX

BSVHF-5223
₹ 1680/- (S.S Tube & Hook)
₹ 1890/- (S.S Heavy Stretchable)



CONTINENTAL

BSVHF-5224
₹ 1280/- (S.S Tube & Hook)
₹ 1450/- (S.S Heavy Stretchable)



MADAME

BSVHF-5225
₹ 920/- (PVC/SS LT. Tube & Hook)
₹ 1090/- (S.S Heavy Stretchable)



SPA

BSVHF-5226
₹ 1090/- (PVC/SS LT. Tube & Hook)
₹ 1260/- (S.S Heavy Stretchable)



ELEGANT
(Square)

BSVHF-5227
₹ 1260/- (PVC/SS Tube & Hook)
₹ 1388/- (S.S Heavy Stretchable)



ELEGANT
(Round)

BSVHF-5228
₹ 1250/- (PVC/SS Tube & Hook)
₹ 1420/- (S.S Heavy Stretchable)



GROHE (Nozzle)
BSVHF-5229
₹ 1150/- (PVC/SS Tube & Hook)
₹ 1344/- (S.S Heavy Stretchable)



DELTA

BSVHF-5230
₹ 1210/- (PVC/SS Tube & Hook)
₹ 1370/- (S.S Heavy Stretchable)



ANGEL

BSVHF-5231
₹ 1230/- (PVC/SS Tube & Hook)
₹ 1400/- (S.S Heavy Stretchable)



SCORPIO

BSVHF-5232
₹ 1230/- (PVC/SS Tube & Hook)
₹ 1400/- (S.S Heavy Stretchable)



CRYSTAL

BSVHF-5233
₹ 1350/- (PVC/SS Tube & Hook)
₹ 1510/- (S.S Heavy Stretchable)



NOVA

BSVHF-5234
₹ 922/- (PVC/SS Tube & Hook)
₹ 1080/- (S.S Heavy Stretchable)



LYRIC (Round)

BSVHF-5236
₹ 1064/- (PVC/SS Tube & Hook)
₹ 1230/- (S.S Heavy Stretchable)



LYRIC (Square)

BSVHF-5237
₹ 1150/- (PVC/SS Tube & Hook)
₹ 1350/- (S.S Heavy Stretchable)



BAJAJ INDUSTRIES LTD

Corporate Office :

1003, R.No. 4, Kalyan Road,
Temghar, Thane, Bhiwandi,
Mumbai, Maharashtra - 421302, India

Email : info@bajajpipes.com | Website : www.bajajpipes.com
Toll Free No. : 18001030585

Follow us on

